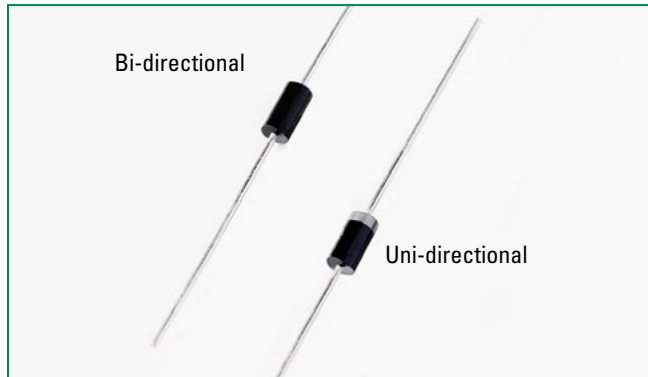


## P6KE Series



### Agency Approvals

AGENCY	AGENCY FILE NUMBER
	E128662/E230531

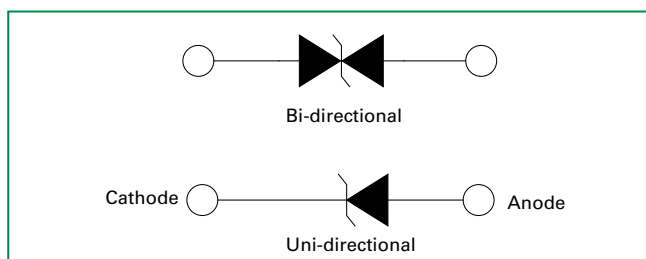
### Maximum Ratings and Thermal Characteristics (T<sub>A</sub>=25°C unless otherwise noted)

Parameter	Symbol	Value	Unit
Peak Pulse Power Dissipation by 10x1000µs Test Waveform (Fig.2) (Note 1)	P <sub>PPM</sub>	600	W
Steady State Power Dissipation on Infinite Heat Sink at T <sub>L</sub> =75°C (Fig. 6)	P <sub>D</sub>	5.0	W
Peak Forward Surge Current, 8.3ms Single Half Sine Wave Unidirectional Only (Note 2)	I <sub>FSM</sub>	100	A
Maximum Instantaneous Forward Voltage at 50A for Unidirectional Only (Note 3)	V <sub>F</sub>	3.5/5.0	V
Operating Junction and Storage Temperature Range	T <sub>J</sub> , T <sub>STG</sub>	-55 to 175	°C
Typical Thermal Resistance Junction to Lead	R <sub>uJL</sub>	20	°C/W
Typical Thermal Resistance Junction to Ambient	R <sub>uJA</sub>	75	°C/W

#### Notes:

1. Non-repetitive current pulse, per Fig. 3 and derated above T<sub>A</sub> = 25°C per Fig. 2.
2. Measured on 8.3ms single half sine wave or equivalent square wave, duty cycle=4 per minute maximum.
3. V<sub>F</sub><3.5V for devices of V<sub>BR</sub> ≤ 200V and V<sub>F</sub>< 5.0V for devices of V<sub>BR</sub> ≥ 201V.

### Functional Diagram



### Description

The P6KE Series is designed specifically to protect sensitive electronic equipment from voltage transients induced by lightning and other transient voltage events.


### Features

- Typical maximum temperature coefficient  $\Delta V_{BR} = 0.1\% \times V_{BR}@25^\circ\text{C} \times \Delta T$
- Glass passivated chip junction in DO-15 Package
- 600W peak pulse capability at 10x1000µs waveform, repetition rate (duty cycles):0.01%
- Fast response time: typically less than 1.0ps from 0 Volts to BV min
- Excellent clamping capability
- Typical failure mode is short from over-specified voltage or current
- Whisker test is conducted based on JEDEC JESD201A per its table 4a and 4c
- IEC-61000-4-2 ESD 15kV(Air), 8kV (Contact)
- ESD protection of data lines in accordance with IEC 61000-4-2 (IEC801-2)
- EFT protection of data lines in accordance with IEC 61000-4-4 (IEC801-4)
- Low incremental surge resistance
- Typical I<sub>R</sub> less than 1µA above 13V
- High temperature soldering guaranteed: 260°C/40 seconds / 0.375"(9.5mm) lead length, 5 lbs., (2.3kg) tension
- Plastic package has underwriters laboratory flammability classification 94V-0
- Matte tin lead-free plated
- Halogen free and RoHS compliant

### Applications

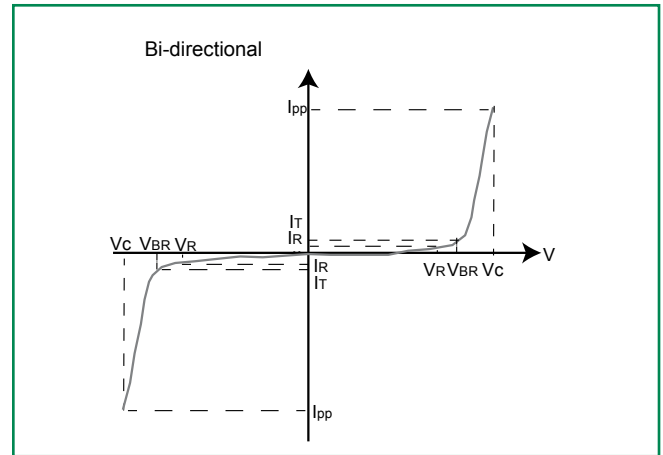
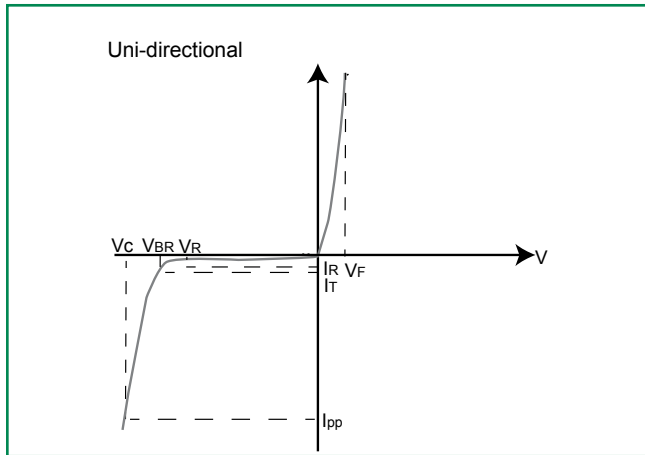
TVS devices are ideal for the protection of I/O interfaces, V<sub>CC</sub> bus and other vulnerable circuits used in telecom, computer, industrial and consumer electronic applications.

### Electrical Characteristics ( $T_A=25^\circ\text{C}$ unless otherwise noted)

Part Number (Uni)	Part Number (Bi)	Reverse Stand off Voltage $V_R$ (Volts)	Breakdown Voltage $V_{BR}$ (Volts) @ $I_T$		Test Current $I_T$ (mA)	Maximum Clamping Voltage $V_C$ @ $I_{pp}$ (V)	Maximum Peak Pulse Current $I_{pp}$ (A)	Maximum Reverse Leakage $I_R$ @ $V_R$ ( $\mu\text{A}$ )	Agency Approval 
			MIN	MAX					
P6KE6.8A	P6KE6.8CA	5.80	6.45	7.14	10	10.5	58.1	1000	X
P6KE7.5A	P6KE7.5CA	6.40	7.13	7.88	10	11.3	54.0	500	X
P6KE8.2A	P6KE8.2CA	7.02	7.79	8.61	10	12.1	50.4	200	X
P6KE9.1A	P6KE9.1CA	7.78	8.65	9.55	1	13.4	45.5	50	X
P6KE10A	P6KE10CA	8.55	9.50	10.50	1	14.5	42.1	10	X
P6KE11A	P6KE11CA	9.40	10.50	11.60	1	15.6	39.1	5	X
P6KE12A	P6KE12CA	10.20	11.40	12.60	1	16.7	36.5	5	X
P6KE13A	P6KE13CA	11.10	12.40	13.70	1	18.2	33.5	1	X
P6KE15A	P6KE15CA	12.80	14.30	15.80	1	21.2	28.8	1	X
P6KE16A	P6KE16CA	13.60	15.20	16.80	1	22.5	27.1	1	X
P6KE18A	P6KE18CA	15.30	17.10	18.90	1	25.2	24.2	1	X
P6KE20A	P6KE20CA	17.10	19.00	21.00	1	27.7	22.0	1	X
P6KE22A	P6KE22CA	18.80	20.90	23.10	1	30.6	19.9	1	X
P6KE24A	P6KE24CA	20.50	22.80	25.20	1	33.2	18.4	1	X
P6KE27A	P6KE27CA	23.10	25.70	28.40	1	37.5	16.3	1	X
P6KE30A	P6KE30CA	25.60	28.50	31.50	1	41.4	14.7	1	X
P6KE33A	P6KE33CA	28.20	31.40	34.70	1	45.7	13.3	1	X
P6KE36A	P6KE36CA	30.80	34.20	37.80	1	49.9	12.2	1	X
P6KE39A	P6KE39CA	33.30	37.10	41.00	1	53.9	11.3	1	X
P6KE43A	P6KE43CA	36.80	40.90	45.20	1	59.3	10.3	1	X
P6KE47A	P6KE47CA	40.20	44.70	49.40	1	64.8	9.4	1	X
P6KE51A	P6KE51CA	43.60	48.50	53.60	1	70.1	8.7	1	X
P6KE56A	P6KE56CA	47.80	53.20	58.80	1	77.0	7.9	1	X
P6KE62A	P6KE62CA	53.00	58.90	65.10	1	85.0	7.2	1	X
P6KE68A	P6KE68CA	58.10	64.60	71.40	1	92.0	6.6	1	X
P6KE75A	P6KE75CA	64.10	71.30	78.80	1	103.0	5.9	1	X
P6KE82A	P6KE82CA	70.10	77.90	86.10	1	113.0	5.4	1	X
P6KE91A	P6KE91CA	77.80	86.50	95.50	1	125.0	4.9	1	X
P6KE100A	P6KE100CA	85.50	95.00	105.00	1	137.0	4.5	1	X
P6KE110A	P6KE110CA	94.00	105.00	116.00	1	152.0	4.0	1	X
P6KE120A	P6KE120CA	102.00	114.00	126.00	1	165.0	3.7	1	X
P6KE130A	P6KE130CA	111.00	124.00	137.00	1	179.0	3.4	1	X
P6KE150A	P6KE150CA	128.00	143.00	158.00	1	207.0	2.9	1	X
P6KE160A	P6KE160CA	136.00	152.00	168.00	1	219.0	2.8	1	X
P6KE170A	P6KE170CA	145.00	162.00	179.00	1	234.0	2.6	1	X
P6KE180A	P6KE180CA	154.00	171.00	189.00	1	246.0	2.5	1	X
P6KE200A	P6KE200CA	171.00	190.00	210.00	1	274.0	2.2	1	X
P6KE220A	P6KE220CA	185.00	209.00	231.00	1	328.0	1.9	1	X
P6KE250A	P6KE250CA	214.00	237.00	263.00	1	344.0	1.8	1	X
P6KE300A	P6KE300CA	256.00	285.00	315.00	1	414.0	1.5	1	X
P6KE350A	P6KE350CA	300.00	332.00	368.00	1	482.0	1.3	1	X
P6KE400A	P6KE400CA	342.00	380.00	420.00	1	548.0	1.1	1	X
P6KE440A	P6KE440CA	376.00	418.00	462.00	1	602.0	1.0	1	X
P6KE480A	P6KE480CA	408.00	456.00	504.00	1	658.0	0.9	1	X
P6KE510A	P6KE510CA	434.00	485.00	535.00	1	698.0	0.9	1	X
P6KE530A	P6KE530CA	477.00	503.50	556.50	1	725.0	0.8	1	X
P6KE540A	P6KE540CA	486.00	513.00	567.00	1	740.0	0.8	1	X
P6KE550A	P6KE550CA	495.00	522.50	577.50	1	760.0	0.8	1	X
P6KE600A	P6KE600CA	512.00	570.00	630.00	1	828.0	0.75	1	X

For bidirectional type having  $V_R$  of 10 volts and less, the  $I_R$  limit is double.  
 For parts without A, the  $V_{BR}$  is  $\pm 10\%$  and  $V_C$  is 5% higher than with A parts

## I-V Curve Characteristics



**$P_{PPM}$  Peak Pulse Power Dissipation** – Max power dissipation

**$V_s$  Stand-off Voltage** – Maximum voltage that can be applied to the TVS without operation

**$V_{BR}$  Breakdown Voltage** – Maximum current that flows through the TVS at a specified test current ( $I_T$ )

**$V_C$  Clamping Voltage** – Peak voltage measured across the suppressor at a specified  $I_{ppm}$  (peak impulse current)

**$I_R$  Reverse Leakage Current** – Current measured at  $V_R$

**$V_F$  Forward Voltage Drop for Uni-directional**

## Ratings and Characteristic Curves ( $T_A=25^\circ\text{C}$ unless otherwise noted)

Figure 1 - TVS Transients Clamping Waveform

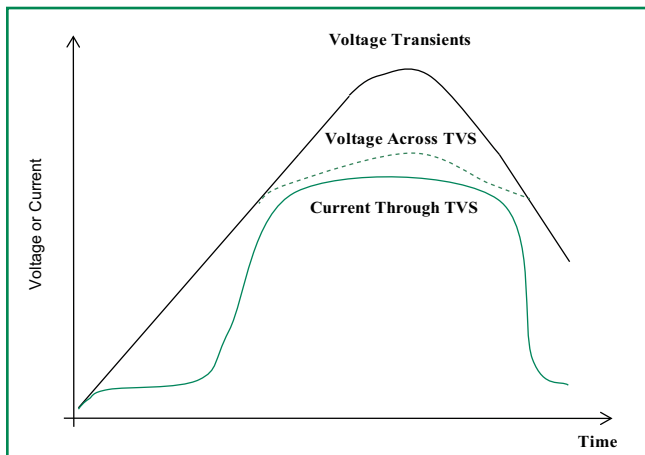
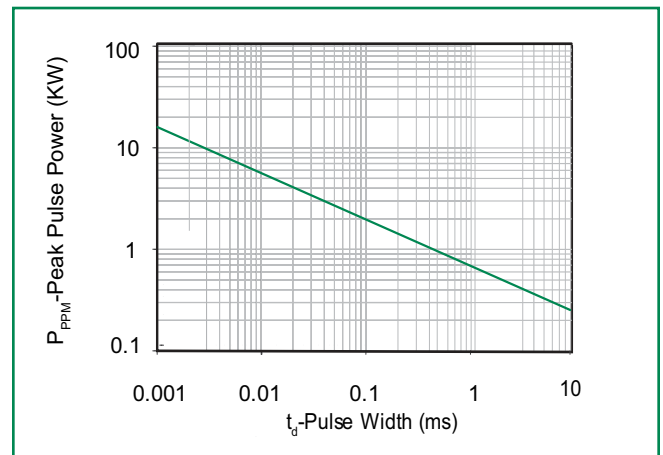


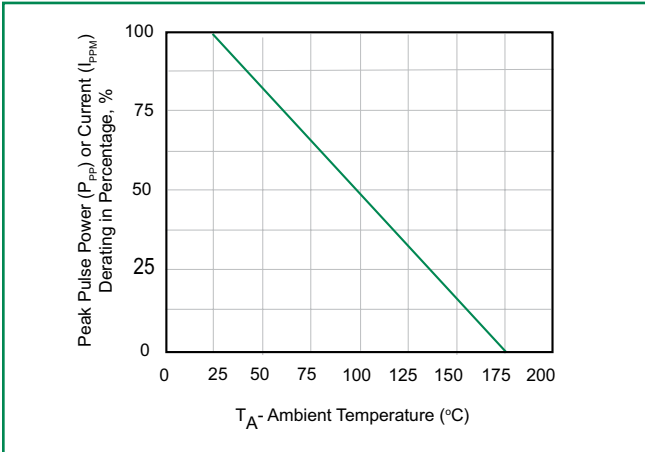
Figure 2 - Peak Pulse Power Rating



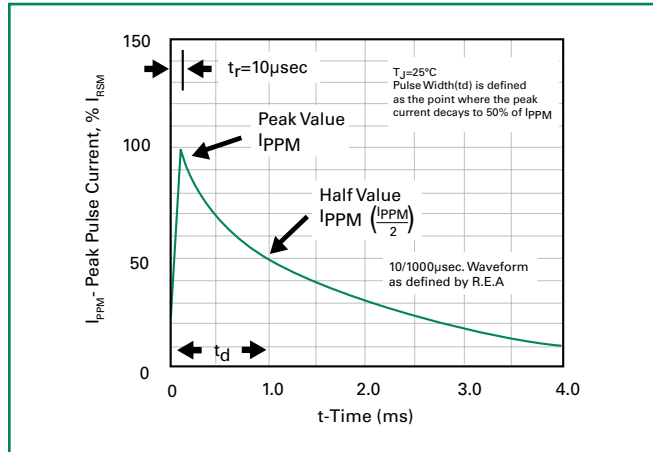
continues on next page.

**Ratings and Characteristic Curves** ( $T_A=25^\circ\text{C}$  unless otherwise noted) (Continued)

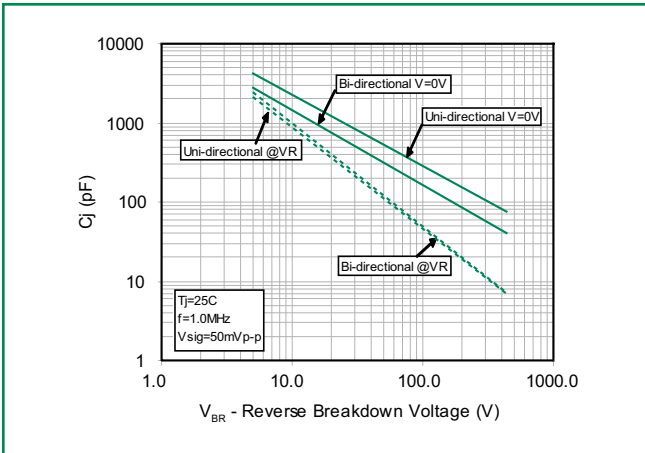
**Figure 3 - Pulse Derating Curve**



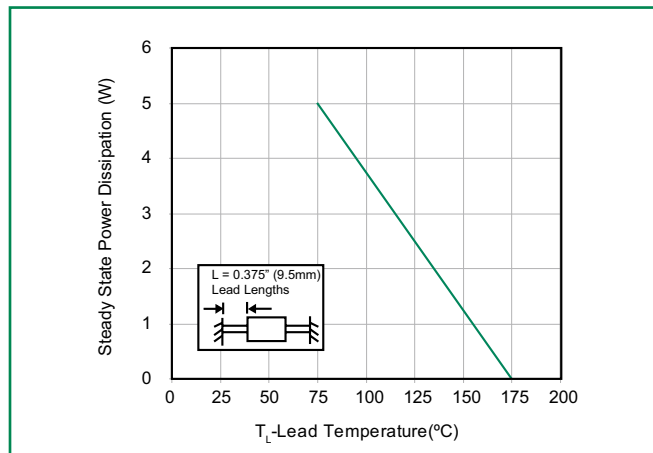
**Figure 4 - Pulse Waveform**



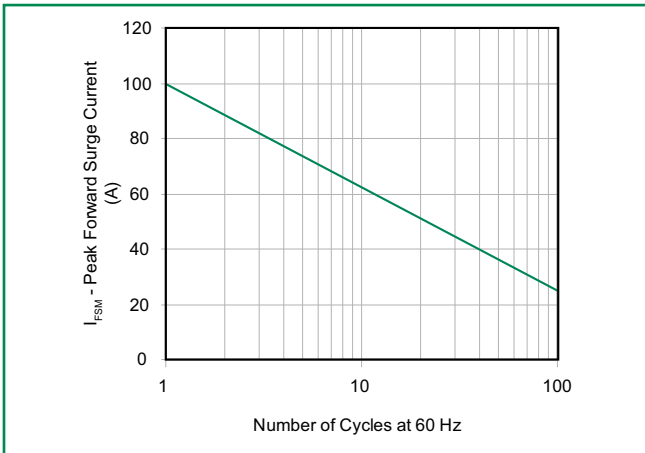
**Figure 5 - Typical Junction Capacitance Uni-Directional**



**Figure 6 - Steady State Power Derating Curve**

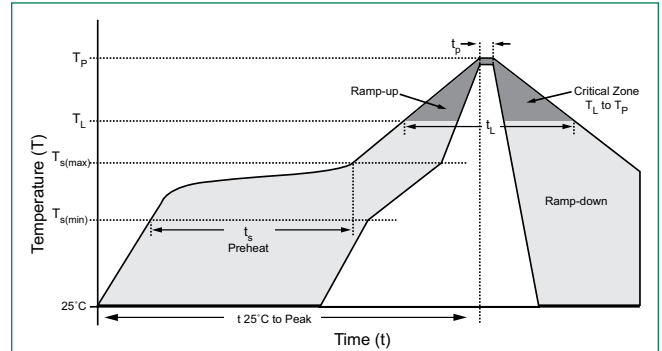


**Figure 7 - Maximum Non-Repetitive Forward Surge Current**



## Soldering Parameters

Reflow Condition		Lead-free assembly
Pre Heat	- Temperature Min ( $T_{s(min)}$ )	150°C
	- Temperature Max ( $T_{s(max)}$ )	200°C
	- Time (min to max) ( $t_s$ )	60 – 180 secs
Average ramp up rate (Liquidus Temp ( $T_L$ ) to peak)		3°C/second max
$T_{s(max)}$ to $T_L$ - Ramp-up Rate		3°C/second max
Reflow	- Temperature ( $T_L$ ) (Liquidus)	217°C
	- Time (min to max) ( $t_s$ )	60 – 150 seconds
Peak Temperature ( $T_p$ )		260 <sup>+0/-5</sup> °C
Time within 5°C of actual peak Temperature ( $t_p$ )		20 – 40 seconds
Ramp-down Rate		6°C/second max
Time 25°C to peak Temperature ( $T_p$ )		8 minutes Max.
Do not exceed		280°C



## Flow/Wave Soldering (Solder Dipping)

Peak Temperature :	265°C
Dipping Time :	10 seconds
Soldering :	1 time

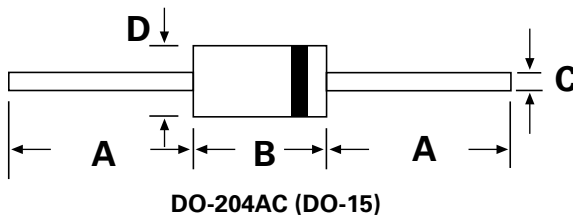
## Physical Specifications

Weight	0.015oz., 0.4g
Case	JEDEC DO-204AC (DO-15) molded plastic body over passivated junction.
Polarity	Color band denotes the cathode except Bipolar.
Terminal	Matte Tin axial leads, solderable per JESD22-B102D.

## Environmental Specifications

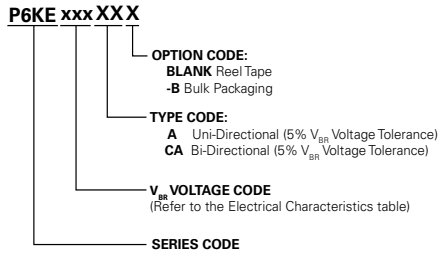
Temperature Cycle	JESD22-A104
Pressure Cooker	JESD 22-A102
High Temp. Storage	JESD22-A103
HTRB	JESD22-A108
Thermal Shock	JESD22-A106

## Dimensions

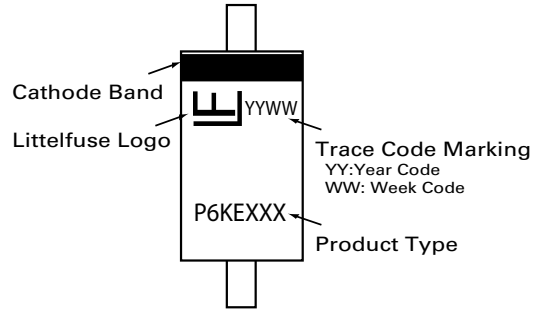


Dimensions	Inches		Millimeters	
	Min	Max	Min	Max
A	1.000	-	25.40	-
B	0.230	0.300	5.80	7.60
C	0.022	0.034	0.56	0.86
D	0.104	0.140	2.60	3.60

### Part Numbering System



### Part Marking System



### Packaging

Part Number	Component Package	Quantity	Packaging Option	Packaging Specification
P6KExxxXX	DO-204AC	4000	Tape & Reel	EIA STD RS-296E
P6KExxxXX-B	DO-204AC	1000	BULK	Littelfuse Concord Packing Spec. DM-0016

### Tape and Reel Specification

