



## 6.2 & 6.55 Volt Zener Reference Diodes

Qualified per MIL-PRF-19500/159

*\*Qualified Levels:  
JAN, JANTX,  
JANTXV and JANS  
(available on some part  
numbers)*

### DESCRIPTION

The 1N821UR-1 – 1N829AUR-1 series of surface mount temperature compensated reference diodes provides both 6.2 V and 6.55 V nominal voltages and temperature coefficients as low as 0.0005 %/°C at a Zener test current of 7.5 mA. These glass surface mount DO-213AA (MELF) reference diodes are optionally available as RoHS compliant for commercial applications. This type of bonded Zener package construction is also available in JAN, JANTX, JANTXV and JANS military qualifications (RoHS compliant option not applicable). Microsemi also offers other Zener Reference Diode products for a variety of voltages up to 200 V.

**Important:** For the latest information, visit our website <http://www.microsemi.com>.

### FEATURES

- Surface mount equivalent of JEDEC registered 1N821 – 1N829 series.
- Zener impedance values of 10 ohms and 15 ohms are available.
- Reference voltage selection of 6.2 V & 6.55 V +/-5% with further tight tolerance options on commercial at lower voltage. (Excludes 1N826 and 1N828.)
- Temperature compensated.
- Internal metallurgical bond.
- Double plug construction.
- \*JAN, JANTX, JANTXV and JANS qualification per MIL-PRF-19500/159 available on 1N821-1, 823-1, 825-1, 827-1 and 829-1.
- RoHS compliant versions available (commercial grade only).

### APPLICATIONS / BENEFITS

- Provides minimal voltage changes over a broad temperature range.
- For instrumentation and other circuit designs requiring a stable voltage reference.
- Maximum temperature coefficient selections available from 0.01 %/°C to 0.0005 %/°C.
- Tight reference voltage tolerances of 1%, 2%, 3%, etc, available on commercial with center nominal value of 6.2 V by special request. (Excludes 1N826 and 1N828.)
- Small surface-mount footprint.
- Non-sensitive to ESD per MIL-STD-750 method 1020.
- Typical low capacitance of 100 pF or less.

### MAXIMUM RATINGS @ T<sub>A</sub> = +25 °C unless otherwise specified

Parameters/Test Conditions	Symbol	Value	Unit
Junction and Storage temperature	T <sub>J</sub> and T <sub>STG</sub>	-55 to +175	°C
Power Dissipation <sup>(1)</sup>	P <sub>D</sub>	500	mW
Maximum Zener Current	I <sub>ZM</sub>	70	mA
Solder Pad Temperatures at 10 s	T <sub>SP</sub>	260	°C

**Notes:** 1. @ T<sub>L</sub> = 25 °C and maximum current I<sub>ZM</sub> of 70 mA. For optimum voltage-temperature stability, I<sub>Z</sub> = 7.5 mA (less than 50 mW in dissipated power). Derate at 3.33 mW/°C above T<sub>A</sub> = +25 °C.

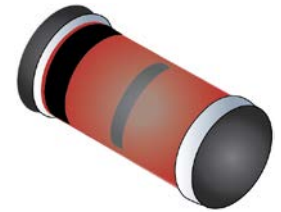

**DO-213AA  
Package**

Also available in:

**DO-35 (DO-204AH)**  
(axial-leaded)

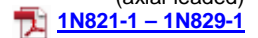

#### MSC – Lawrence

6 Lake Street,  
Lawrence, MA 01841  
1-800-446-1158  
Tel: (978) 620-2600  
Fax: (978) 689-0803

#### MSC – Ireland

Gort Road Business Park,  
Ennis, Co. Clare, Ireland  
Tel: +353 (0) 65 6840044  
Fax: +353 (0) 65 6822298

**Website:**

[www.microsemi.com](http://www.microsemi.com)

**MECHANICAL and PACKAGING**

- CASE: Hermetically sealed glass case. DO-213AA package.
- TERMINALS: Tin-lead (military) or RoHS compliant annealed matte-tin plating (commercial grade only) solderable per MIL-STD-750, Method 2026.
- MARKING: Cathode band (except double anode 1N822 and 1N824).
- POLARITY: Reference diode to be operated with the banded end positive with respect to the opposite end.
- MOUNTING SURFACE SELECTION: The Axial Coefficient of Expansion (COE) of this device is approximately +6PPM/°C. The COE of the mounting surface system should be selected to provide a suitable match with this device.
- TAPE & REEL option: Standard per EIA-481-B with 12 mm tape (add "TR" suffix to part number). Consult factory for quantities.
- WEIGHT: Approximately 0.04 grams.
- See [Package Dimensions](#) on last page.

**PART NOMENCLATURE**

*Applicable to: JAN, JANTX, JANTXV and JANS of 1N821, 1N823, 1N825, 1N827, and 1N829 only:*

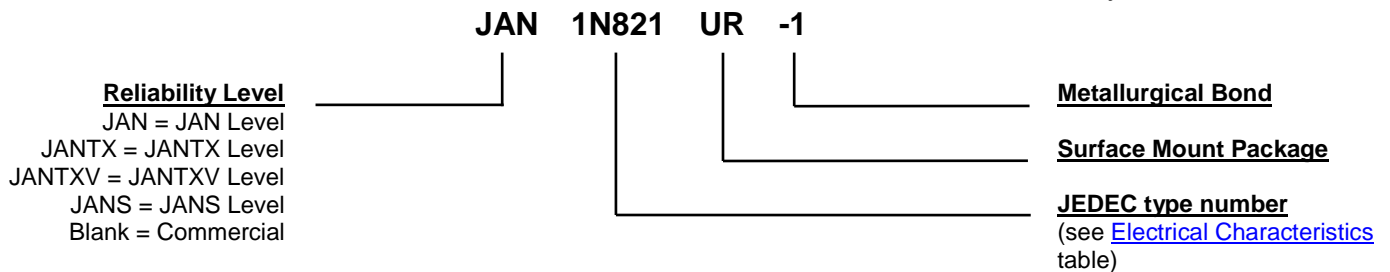

*Applicable to: commercial 1N821, 1N823, 1N825, 1N827, and 1N829 only:*

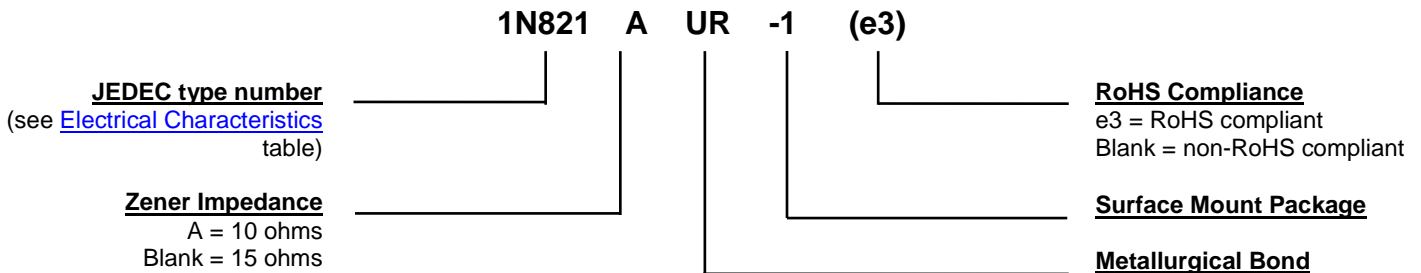

*Applicable to: 1N822, 1N824, 1N826 and 1N828 only:*

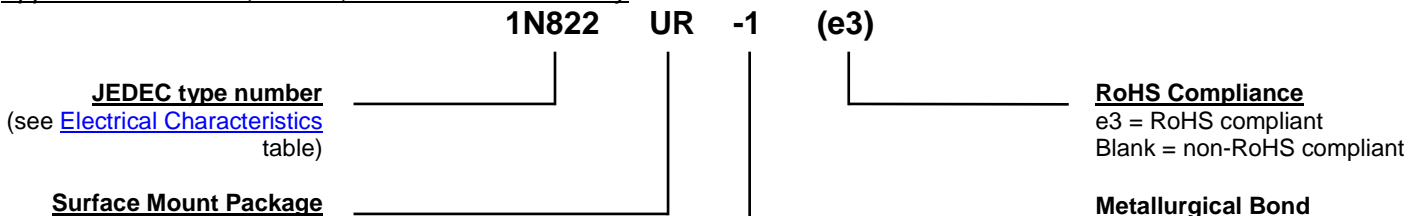

SYMBOLS & DEFINITIONS	
Symbol	Definition
$I_R$	Reverse Current: The maximum reverse (leakage) current that will flow at the specified voltage and temperature.
$I_Z, I_{ZT}, I_{ZK}$	Regulator Current: The dc regulator current ( $I_Z$ ), at a specified test point ( $I_{ZT}$ ), near breakdown knee ( $I_{ZK}$ ).
$V_Z$	Zener Voltage: The Zener voltage the device will exhibit at a specified current ( $I_Z$ ) in its breakdown region.
$Z_{ZT}$ or $Z_{ZK}$	Dynamic Impedance: The small signal impedance of the diode when biased to operate in its breakdown region at a specified rms current modulation (typically 10% of $I_{ZT}$ or $I_{ZK}$ ) and superimposed on $I_{ZT}$ or $I_{ZK}$ respectively.

**ELECTRICAL CHARACTERISTICS @ 25 °C (unless otherwise specified)**

JEDEC TYPE NUMBER	ZENER VOLTAGE $V_Z$ @ $I_{ZT}$ (Note 3)	ZENER TEST CURRENT $I_{ZT}$	MAXIMUM ZENER IMPEDANCE $Z_{ZT}$ @ $I_{ZT}$ (Note 1)	MAXIMUM REVERSE CURRENT $I_R$ @ 3 V	VOLTAGE TEMPERATURE STABILITY ( $\Delta V_{ZT}$ MAX) -55°C to +100°C (Note 2 and 3)	EFFECTIVE TEMPERATURE COEFFICIENT $\alpha_{VZ}$
	Volts	mA	Ohms	$\mu A$	mV	% / °C
1N821UR-1	5.89-6.51	7.5	15	2	96	0.01
1N821AUR-1	5.89-6.51	7.5	10	2	96	0.01
1N822UR-1†	5.9-6.5	7.5	15	2	96	0.01
1N823UR-1	5.89-6.51	7.5	15	2	48	0.005
1N823AUR-1	5.89-6.51	7.5	10	2	48	0.005
1N824UR-1†	5.9-6.5	7.5	15	2	48	0.005
1N825UR-1	5.89-6.51	7.5	15	2	19	0.002
1N825AUR-1	5.89-6.51	7.5	10	2	19	0.002
1N826UR-1	6.2-6.9	7.5	15	2	20	0.002
1N827UR-1	5.89-6.51	7.5	15	2	9	0.001
1N827AUR-1	5.89-6.51	7.5	10	2	9	0.001
1N828UR-1	6.2-6.9	7.5	15	2	10	0.001
1N829UR-1	5.89-6.51	7.5	15	2	5	0.0005
1N829AUR-1	5.89-6.51	7.5	10	2	5	0.0005

† Double Anode: Electrical specifications apply under both bias polarities.

- NOTES:**
1. Zener impedance is measured by superimposing 0.75 mA ac rms on 7.5 mA dc @ 25 °C.
  2. The maximum allowable change observed over the entire temperature range i.e., the diode voltage will not exceed the specified mV change at any discrete temperature between the established limits.
  3. Voltage measurements to be performed 15 seconds after application of dc current.
  4. This product series has been previously identified as CDLL821 thru CDLL829A-1. This alternate number may still be in use.

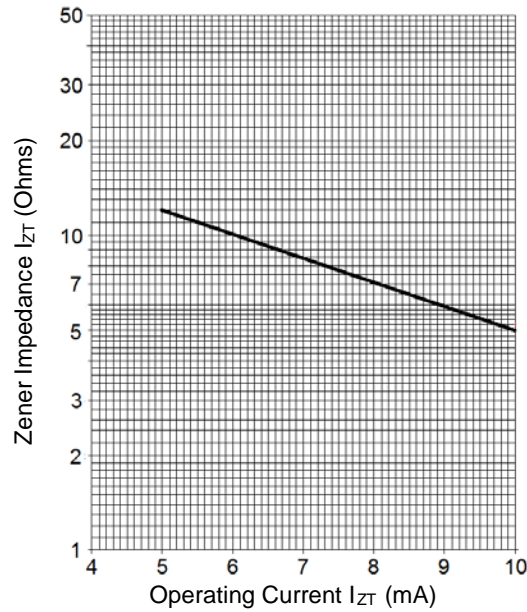
**GRAPHS**

**FIGURE 1**  
**TYPICAL ZENER IMPEDANCE vs OPERATING CURRENT**

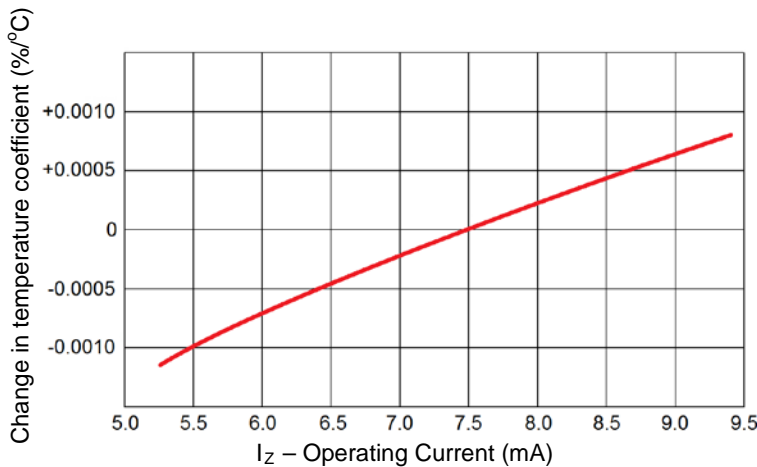

**FIGURE 2**  
**TYPICAL CHANGE OF TEMPERATURE COEFFICIENT WITH CHANGE IN OPERATING CURRENT**

The curve shown in Figure 2 is typical of the diode series and greatly simplifies the estimation of the Temperature Coefficient (TC) when the diode is operated at currents other than 7.5 mA.

**EXAMPLE:** A diode in this series is operated at a current of 7.5 mA and has specified Temperature Coefficient (TC) limits of  $\pm 0.005$  %/°C. To obtain the typical Temperature Coefficient limits for this same diode operated at a current of 6.0 mA, the new TC limits (%/°C) can be estimated using the graph in Figure 2. At a test current of 6.0 mA the change in Temperature Coefficient (TC) is approximately  $-0.0006$  %/°C. The algebraic sum of  $\pm 0.005$  %/°C and  $-0.0006$  %/°C gives the new estimated limits of  $+0.0044$  %/°C and  $-0.0056$  %/°C.

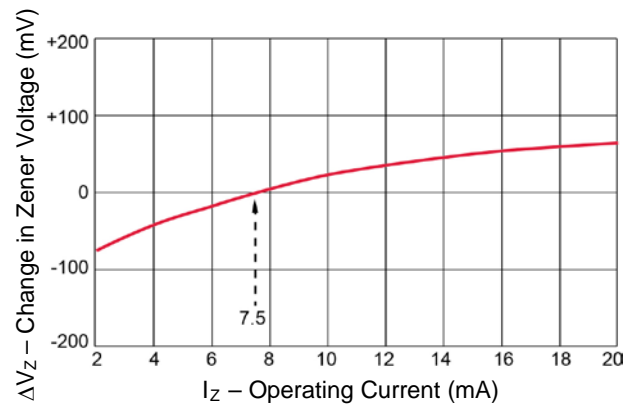

**FIGURE 3**  
**TYPICAL CHANGE OF ZENER VOLTAGE WITH CHANGE IN OPERATING CURRENT**

This curve in Figure 3 illustrates the change of diode voltage arising from the effect of impedance. It is in effect an exploded view of the Zener operating region of the I-V characteristic.

In conjunction with Figure 2, this curve can be used to estimate total voltage regulation under conditions of both varying temperature and current.

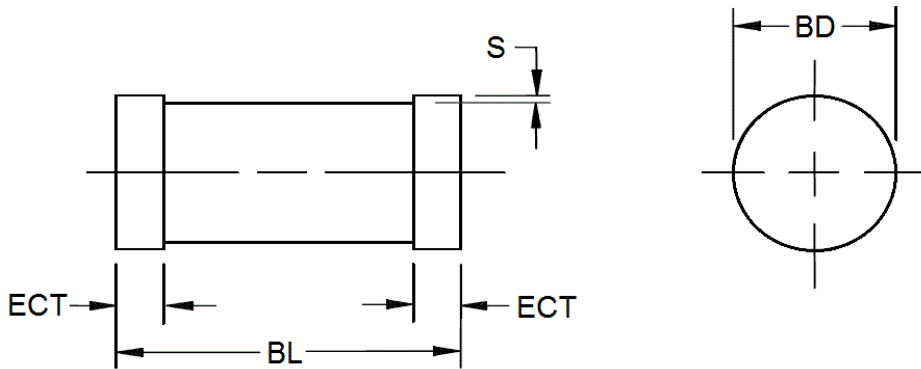
**PACKAGE DIMENSIONS**

Symbol	Dimensions			
	Inch		Millimeters	
	Min	Max	Min	Max
<b>BD</b>	0.063	0.067	1.60	1.70
<b>BL</b>	0.130	0.146	3.30	3.71
<b>ECT</b>	0.016	0.022	0.41	0.56
<b>S</b>	0.001 Min		0.03 Min	

**NOTES:**

1. Dimensions are in inches.
2. Millimeters are given for information only.
3. In accordance with ASME Y14.5M, diameters are equivalent to  $\Phi$ x symbology.

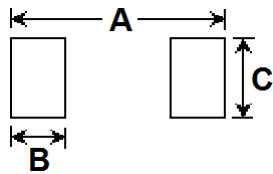
**PAD LAYOUT**

	Inch	mm
<b>A</b>	0.200	5.08
<b>B</b>	0.055	1.40
<b>C</b>	0.080	2.03