

Features

- Ideally Suited for Automatic Insertion
- Complementary PNP Types Available (BC856 – BC858)
- For switching and AF Amplifier Applications
- **Lead Free, RoHS Compliant (Note 1)**
- **Halogen and Antimony Free "Green" Device (Note 2)**
- **Qualified to AEC-Q101 Standards for High Reliability**

Mechanical Data

- Case: SOT-23
- UL Flammability Rating 94V-0
- Case material: molded Plastic "Green" Compound
- Moisture Sensitivity: Level 1 per J-STD-020
- Terminals: Matte Tin Finish
- Weight: 0.008 grams (Approximate)

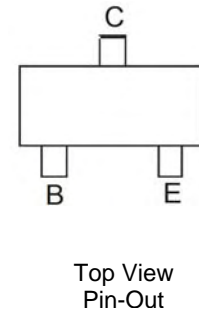
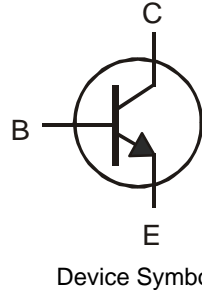

Ordering Information (Note 3 & 4)

Product	Marking	Reel size (inches)	Quantity per reel
BC846A-7-F	K1Q	7	3,000
BC846B-7-F	K1R	7	3,000
BC846BQ-7-F	K1R	7	3,000
BC846B-13-F	K1R	13	10,000
BC847A-7-F	K1Q	7	3,000
BC847AQ-7-F	K1Q	7	3,000
BC847A-13-F	K1Q	13	10,000
BC847B-7-F	K1R	7	3,000
BC847BQ-7-F	K1R	7	3,000
BC847B-13-F	K1R	13	10,000

Product	Marking	Reel size (inches)	Quantity per reel
BC847C-7-F	K1M	7	3,000
BC847C-13-F	K1M	13	10,000
BC848A-7-F	K1Q	7	3,000
BC848B-7-F	K1R	7	3,000
BC848B-13-F	K1R	13	10,000
BC848C-7-F	K1M	7	3,000
BC848CQ-7-F	K1M	7	3,000

- Notes:
1. No purposefully added lead.
 2. Diodes Inc.'s "Green" Policy can be found on our website at <http://www.diodes.com>
 3. Tape width is 8mm. For more packaging details, go to our website at <http://www.diodes.com>.
 4. Products with Q-suffix are automotive grade. All other products are commercial grade.

Marking Information

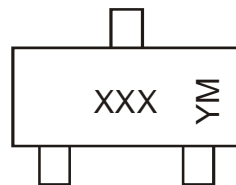

XXX = Product Type Marking Code,
 YM = Date Code Marking
 Y = Year ex: X = 2010
 M = Month ex: 9 = September

Date Code Key

Year	2010	2011	2012	2013	2014	2015	2016	2017
Code	X	Y	Z	A	B	C	D	E

Month	Jan	Feb	Mar	Apr	May	Jun	Jul	Aug	Sep	Oct	Nov	Dec
Code	1	2	3	4	5	6	7	8	9	O	N	D

Maximum Ratings @ $T_A = 25^\circ\text{C}$ unless otherwise specified

Characteristic		Symbol	Value	Unit
Collector-Base Voltage	BC846	V_{CBO}	80	V
	BC847		50	
	BC848		30	
Collector-Emitter Voltage	BC846	V_{CEO}	65	V
	BC847		45	
	BC848		30	
Emitter-Base Voltage	BC846, BC847	V_{EBO}	6.0	V
	BC848		5.0	
Continuous Collector Current		I_C	100	mA
Peak Collector Current		I_{CM}	200	mA
Peak Emitter Current		I_{EM}	200	mA

Thermal Characteristics @ $T_A = 25^\circ\text{C}$ unless otherwise specified

Characteristic		Symbol	Value	Unit
Power Dissipation	(Note 5)	P_D	300	mW
Thermal Resistance, Junction to Ambient	(Note 5)	$R_{\theta JA}$	417	$^\circ\text{C}/\text{W}$
Operating and Storage Temperature Range		T_J, T_{STG}	-65 to +150	$^\circ\text{C}$

Notes: 5. For a device surface mounted on minimum recommended pad layout FR4 PCB with high coverage of single sided 1oz copper in still air conditions; the device is measured when operating in a steady-state condition.

Electrical Characteristics @T_A = 25°C unless otherwise specified

Characteristic		Symbol	Min	Typ	Max	Unit	Test Condition
Collector-Base Breakdown Voltage	BC846	BV _{CBO}	80	-	-	V	I _C = 10μA
	BC847		50				
	BC848		30				
Collector-Emitter Breakdown Voltage (Note 6)	BC846	BV _{CEO}	65	-	-	V	I _C = 10mA
	BC847		45				
	BC848		30				
Emitter-Base Breakdown Voltage	BC846 / BC847	BV _{EBO}	6	-	-	V	I _E = 1μA
	BC848		5				
Collector Cutoff Current		I _{CBO}	-	-	15 5	μA	V _{CB} = 40V V _{CB} = 30V, T _A = 150°C
Collector Emitter Cutoff Current	BC846	I _{CES}	-	-	15	nA	V _{CE} = 80V
	BC847				15		V _{CE} = 50V
	BC848				15		V _{CE} = 30V
Small Signal Current Gain (Note 6)	BC846A / BC847A / BC848A	h _{fe}	-	-	200	-	-
	BC846B / BC847B / BC848B				330		
	BC847C / BC848C				600		
Input Impedance (Note 6)	BC846A / BC847A / BC848A	h _{ie}	-	-	2.7	kΩ	I _C = 2.0mA, V _{CE} = 5V f = 1.0kHz
	BC846B / BC847B / BC848B				4.5		
	BC847C / BC848C				8.7		
Output Admittance (Note 6)	BC846A / BC847A / BC848A	h _{oe}	-	-	18	μS	
	BC846B / BC847B / BC848B				30		
	BC847C / BC848C				60		
Reverse Voltage Transfer Ratio (Note 6)	BC846A / BC847A / BC848A	h _{re}	-	-	1.5x10 ⁻⁴	-	
	BC846B / BC847B / BC848B				2x10 ⁻⁴		
	BC847C / BC848C				3x10 ⁻⁴		
DC Current Gain (Note 6)	BC846A / BC847A / BC848A	h _{FE}	110	180	220	-	I _C = 2.0mA, V _{CE} = 5V
	BC846B / BC847B / BC848B		200	290	450		
	BC847C / BC848C		420	520	800		
Collector-Emitter Saturation Voltage (Note 6)		V _{CE(sat)}	-	-	90	mV	I _C = 10mA, I _B = 0.5mA
					200		600
Base-Emitter Turn-On Voltage (Note 6)		V _{BE(on)}	580	660	700	mV	I _C = 2mA, V _{CE} = 5V
			-	-	770		I _C = 10mA, V _{CE} = 5V
Base-Emitter Saturation Voltage (Note 6)		V _{BE(sat)}	-	-	700	mV	I _C = 10mA, I _B = 0.5mA
					900		I _C = 100mA, I _B = 5mA
Output Capacitance		C _{obo}	-	3	-	pF	V _{CB} = 10V, f = 1.0MHz
Transition Frequency		f _T	100	300	-	MHz	V _{CE} = 5V, I _C = 10mA, f = 100MHz
Noise Figure		NF	-	2	10	dB	V _{CE} = 5V, I _C = 200μA R _S = 2kΩ, f = 1kHz Δf = 200Hz

Note: 6. Short duration pulse test used to minimize self-heating effect.

Typical Electrical Characteristics

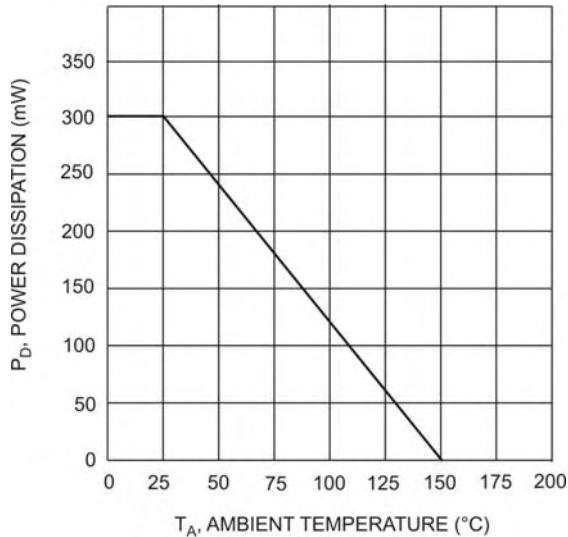

T_A , AMBIENT TEMPERATURE (°C)
Fig. 1, Max Power Dissipation vs Ambient Temperature

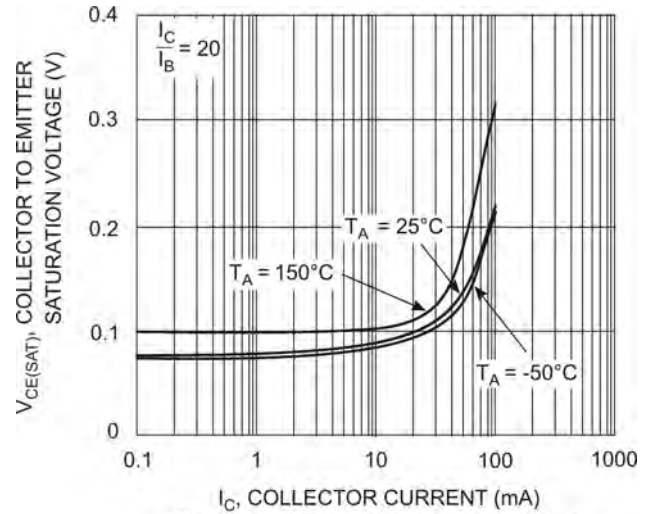

I_C , COLLECTOR CURRENT (mA)
Fig. 2 Collector Emitter Saturation Voltage vs. Collector Current

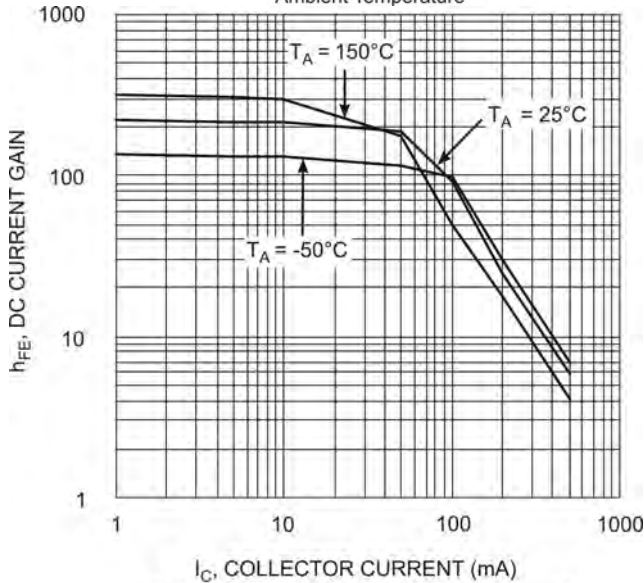

I_C , COLLECTOR CURRENT (mA)
Fig. 3, DC Current Gain vs. Collector Current

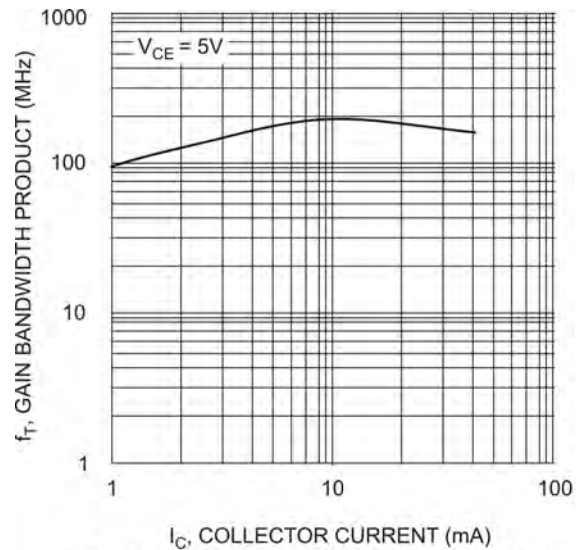

I_C , COLLECTOR CURRENT (mA)
Fig. 4, Gain Bandwidth Product vs Collector Current

Package Outline Dimensions

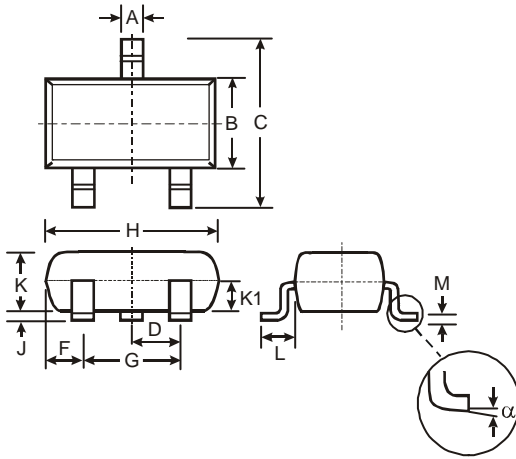

SOT23			
Dim	Min	Max	Typ
A	0.37	0.51	0.40
B	1.20	1.40	1.30
C	2.30	2.50	2.40
D	0.89	1.03	0.915
F	0.45	0.60	0.535
G	1.78	2.05	1.83
H	2.80	3.00	2.90
J	0.013	0.10	0.05
K	0.903	1.10	1.00
K1	-	-	0.400
L	0.45	0.61	0.55
M	0.085	0.18	0.11
α	0°	8°	-
All Dimensions in mm			

Suggested Pad Layout

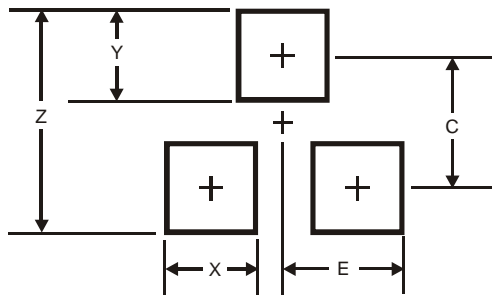

Dimensions	Value (in mm)
Z	2.9
X	0.8
Y	0.9
C	2.0
E	1.35

IMPORTANT NOTICE

DIODES INCORPORATED MAKES NO WARRANTY OF ANY KIND, EXPRESS OR IMPLIED, WITH REGARDS TO THIS DOCUMENT, INCLUDING, BUT NOT LIMITED TO, THE IMPLIED WARRANTIES OF MERCHANTABILITY AND FITNESS FOR A PARTICULAR PURPOSE (AND THEIR EQUIVALENTS UNDER THE LAWS OF ANY JURISDICTION).

Diodes Incorporated and its subsidiaries reserve the right to make modifications, enhancements, improvements, corrections or other changes without further notice to this document and any product described herein. Diodes Incorporated does not assume any liability arising out of the application or use of this document or any product described herein; neither does Diodes Incorporated convey any license under its patent or trademark rights, nor the rights of others. Any Customer or user of this document or products described herein in such applications shall assume all risks of such use and will agree to hold Diodes Incorporated and all the companies whose products are represented on Diodes Incorporated website, harmless against all damages.

Diodes Incorporated does not warrant or accept any liability whatsoever in respect of any products purchased through unauthorized sales channel. Should Customers purchase or use Diodes Incorporated products for any unintended or unauthorized application, Customers shall indemnify and hold Diodes Incorporated and its representatives harmless against all claims, damages, expenses, and attorney fees arising out of, directly or indirectly, any claim of personal injury or death associated with such unintended or unauthorized application.

Products described herein may be covered by one or more United States, international or foreign patents pending. Product names and markings noted herein may also be covered by one or more United States, international or foreign trademarks.

LIFE SUPPORT

Diodes Incorporated products are specifically not authorized for use as critical components in life support devices or systems without the express written approval of the Chief Executive Officer of Diodes Incorporated. As used herein:

- A. Life support devices or systems are devices or systems which:
 - 1. are intended to implant into the body, or
 - 2. support or sustain life and whose failure to perform when properly used in accordance with instructions for use provided in the labeling can be reasonably expected to result in significant injury to the user.
- B. A critical component is any component in a life support device or system whose failure to perform can be reasonably expected to cause the failure of the life support device or to affect its safety or effectiveness.

Customers represent that they have all necessary expertise in the safety and regulatory ramifications of their life support devices or systems, and acknowledge and agree that they are solely responsible for all legal, regulatory and safety-related requirements concerning their products and any use of Diodes Incorporated products in such safety-critical, life support devices or systems, notwithstanding any devices- or systems-related information or support that may be provided by Diodes Incorporated. Further, Customers must fully indemnify Diodes Incorporated and its representatives against any damages arising out of the use of Diodes Incorporated products in such safety-critical, life support devices or systems.

Copyright © 2011, Diodes Incorporated

www.diodes.com