



Datasheet Technology



**TNC Connectors**



## TNC Connectors

### Description

Developed in the late 1950's, the TNC stands for Threaded Neill Concelman and is named after Amphenol engineer Carl Concelman. Designed as a threaded version of the BNC, the TNC series features screw threads for mating. TNC connectors are miniature, threaded weatherproof units with a constant 50  $\Omega$  impedance, operating from DC – 11 GHz.

There are two types of TNC connectors: Standard and Reverse Polarity. Reverse polarity is a keying system accomplished with a reverse interface, and ensures that reverse polarity interface connectors do not mate with standard interface connectors. Amphenol accomplishes this by inserting female contacts into plugs and male contacts into jacks. Other manufacturers may use reverse threading to accomplish reverse polarity keying.

Amphenol's commercial grade connector offering carries the part number designation "RFX" for easy recognition. These low-cost connectors typically utilize die cast and mold-  
ed components. While performance will not be equal to the industrial or military grade products, these connectors are ideal for use on a variety of commercial applications.

### Features/Benefits

- Threaded coupling interface ensures connector will not de-couple in vibration-intensive applications.
- Available in both standard and reverse polarity interfaces.
- Performance from DC – 11 GHz operations in many applications.

### Applications

- Antennas
- Base Stations
- Cable Assemblies
- Cellular
- Instrumentation
- Mil-Aero
- WLAN Networks
- Radar
- Telecom
- RFID Readers

## Standard TNC Specifications

### Electrical

Impedance	50 Ω nominal
Frequency range	DC - 11 GHz
VSWR	1.3 max. @ DC - 11 GHz (straight) 1.35 max. @ DC - 11 GHz (right-angle)
RF-leakage	60 dB minimum @ 3 GHz
Voltage rating (at sea level)	≥ 500 V peak (depending on cable)
Contact resistance	center contact: ≤ 1.5 mΩ outer contact: ≤ 0.2 mΩ braid to body: ≤ 0.1 mΩ
Insulation resistance	5,000 MΩ minimum
Insertion loss maximum	0.18 dB @ 9 GHz
Dielectric withstanding voltage	1,500 Vrms (at sea level)

### Mechanical

Mating	7/16 threaded coupling (MIL-STD-348)
Coupling torque, min./max.	4.1 / 6.1 in-lbs (46 / 69 N-cm), recommended
Coupling nut retention force	101 lbs (450N) min.
Braid/Jacket cable affixment	Hex crimp or screw-threaded clamps
Durability (matings)	500 cycles minimum

### Environmental

Temperature range	-65°C to +165°C
Weatherproof	crimp: w/ heat shrink tubing, clamp: w/ gasket
Hermetic seals	Helium leak test, 2 x 10 <sup>-8</sup> cc/sec.
Thermal shock	MIL-STD-202, method 107, cond. B
Moisture resistance	MIL-STD-202, method 106
Corrosion	MIL-STD-202, method 101, cond. B
Vibration	MIL-STD-202, method 204, cond. B
Mechanical shock	MIL-STD-202, method 213, cond. G
Altitude	MIL-STD-202, method 105, cond. C

### Material

Male contact	Brass, gold plated
Female contact	Beryllium copper or phosphor bronze, silver or gold plated
Crimp ferrule	Copper or brass, nickel plated
Other metal parts	Brass, nickel plated (except M39012 silver plated)
Insulator	PTFE, copolymer of styrene, glass TFE (hermetically sealed)
Gasket	Silicone or synthetic rubber

### Plug

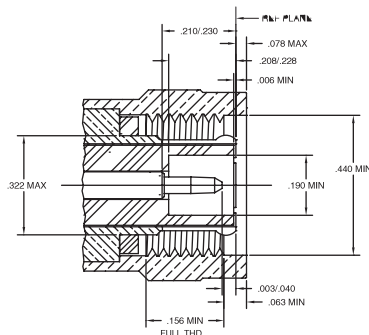

### Jack

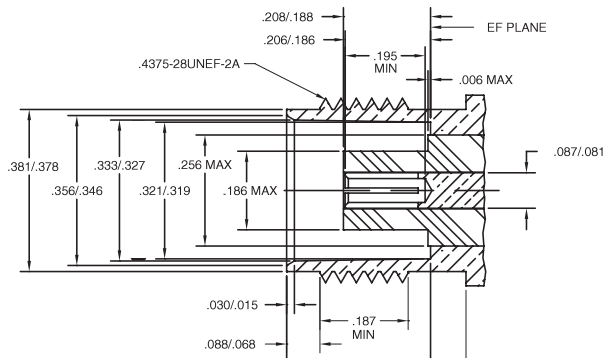

Note: These characteristics are typical but may not apply to all connectors.

## Cable Connectors

## Straight Plugs



Cable Group	Part Number	Plating		Termination	
		Body	Contact	Body	Contact
B	031-2315	Nickel	Gold	Crimp	Crimp
B	031-2315-RFX	Nickel	Gold	Crimp	Crimp
B1	031-2242-RFX	Nickel	Gold	Crimp	Solder
B3	031-6147	Nickel	Gold	Crimp	Crimp
C	031-2367	Nickel	Gold	Crimp	Crimp
C	031-2367-RFX	Nickel	Gold	Crimp	Crimp
C	000-79875	Nickel	Silver	Clamp	Solder
C	000-79875-RFX	Nickel	Silver	Clamp	Crimp or Solder
C, C1	031-6148	White Bronze	Gold	Clamp	Crimp
C1	031-2373	Nickel	Silver	Crimp	Crimp
C2	031-6138	Nickel	Gold	Crimp	Solder
D	031-6142	Nickel	Gold	Crimp	Solder
D	031-5987-RFX	Nickel	Gold	Clamp	Solder
E	031-2368	Nickel	Gold	Crimp	Crimp
E	031-2368-RFX	Nickel	Gold	Crimp	Crimp
F	031-6143	Nickel	Gold	Crimp	Solder
F1	031-6153	Nickel	Gold	Clamp	Solder
G2	031-6000-RFX	Nickel	Gold	Crimp	Solder
G3	031-6001-RFX	Nickel	Gold	Crimp	Solder
G4	031-6154	Nickel	Gold	Clamp	Solder
G4	031-6140	Nickel	Gold	Crimp	Crimp
K	031-6141	Nickel	Gold	Crimp	Solder
L	031-6145	Nickel	Gold	Solder	Crimp
L2	031-6144	Gold	Gold	Solder	Crimp

## Angle Plugs



Cable Group	Part Number	Plating		Termination	
		Body	Contact	Body	Contact
B	031-6160	Nickel	Gold	Crimp	Solder
B1	031-6162	Nickel	Gold	Crimp	Solder
B2	031-6161	Nickel	Gold	Crimp	Solder
B3	031-6163	Gold	Gold	Crimp	Solder
C	031-5849-RFX	Nickel	Gold	Crimp	Solder
C	031-6156	Nickel	Gold	Crimp	Solder
C1	031-6157	Nickel	Gold	Crimp	Solder
E	031-6158	Nickel	Gold	Solder	Crimp
G2	031-6003-RFX	Nickel	Gold	Crimp	Solder
G3	031-6002-RFX	Nickel	Gold	Crimp	Solder
L	031-6165	Gold	Gold	Solder	Solder
L2	031-6164	Nickel	Gold	Solder	Solder

### Straight Bulkhead Jacks

Cable Group	Part Number	Plating		Termination	
		Body	Contact	Body	Contact
B	031-2318	Nickel	Gold	Crimp	Crimp
B	031-2318-RFX	Nickel	Gold	Crimp	Crimp
B	031-6176	Nickel	Gold	Crimp	Crimp
E	031-5859-RFX	Nickel	Gold	Crimp	Crimp
G3	031-6171	Nickel	Gold	Crimp	Crimp
A	031-6177	Nickel	Gold	Crimp	Crimp
B	031-6174	Nickel	Gold	Crimp	Solder
B3	031-6175	Nickel	Gold	Crimp	Solder
C	031-6166	Nickel	Gold	Crimp	Crimp
C1	031-6169	Nickel	Gold	Crimp	Crimp
L	031-6178	Nickel	Gold	Solder	Solder
L2	031-6179	Nickel	Gold	Solder	Crimp
C2	031-6170	Nickel	Gold	Crimp	Crimp



### Rear Mount Bulkhead Jacks: 4 Hole Flange

Cable Group	Part Number	Plating		Termination	
		Body	Contact	Body	Contact
L	031-6180	Nickel	Gold	Solder	Solder
L2	031-6181	Nickel	Gold	Solder	Solder

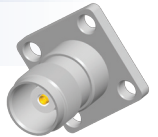

## Receptacles

### Rear Mount Bulkhead Jacks: 4 Hole Flange

Part Number	Body	Plating	
		Body	Contact
031-2300	Nickel	Nickel	Gold
031-2300-RFX	Nickel	Nickel	Silver

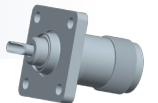

## Printed Circuit Board Connectors

### Angle Jacks

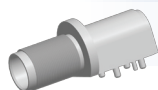

Part Number	Body	Plating	Contact
031-5607	Matte Tin		Silver
031-5660	Nickel		Gold
031-6294	Matte Tin		Gold

### Straight Jacks

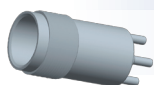

Part Number	Body	Plating	Contact
031-71063	Nickel		Gold
031-6293	Matte Tin		Gold

## Adapters

### Straight Jack to Jack

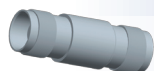

Part Number	Body	Plating	Contact	Description
031-4791	Nickel		Silver	Jack to Jack
031-6203	Nickel		Gold	Plug to Plug

### Bulkhead Jack to Jack



Part Number	Body	Plating	Contact	Description
031-6198	Nickel		Gold	Bulkhead with Gasket
031-6201	Nickel		Gold	Bulkhead without Gasket

### Angle Jack to Plug



Part Number	Body	Plating	Contact
000-79125	Nickel		Gold

### Tee Jack-Plug-Jack



Part Number	Body	Plating	Contact
000-79700	Nickel		Silver

# Reverse Polarity Connectors

## Angle Jacks

Part Number	Body	Plating	Contact
031-5684	Nickel		Gold
031-6031	Nickel		Gold
031-5685	Nickel		Gold
031-6030	Nickel		Gold
031-5680	Nickel		Gold
031-5686	Nickel		Gold
031-6033	Nickel		Gold
031-5677-1000	Nickel		Gold
031-6032	Nickel		Gold
031-6293	Matte Tin		Gold

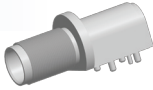

<b>Cable Group</b>	<b>Cable Type</b>
A	RG-178, 196
B	RG-174, 188A, 316, Belden 7805
B1	RG-179, 187, Belden 9221
B2	RD-188/U, RD-316/U
B3	RD-179/U, AT&T 19224L2
C	RG-58, 58A, 58C, 141, 303, LMR195, Belden 7806A, 9907
C1	RG-55, 142, 223, 400
C2	LMR200, Belden 7807A
D	RG-58/U Plenum, Thinnet, RG-122/U, Belden 88240, 89907
E	RG-59, 62, 140, 210, Belden 8241, 8263, 8279, 9209
E1	RG-59/U 20 AWG center conductor, Belden 1426A, 1505A, 9100, 9278
E2	RD-59/U, Belden 8281, 9141, 9231
E3	RG-59/U Quad Shield, Belden 1152A
F	RG-59/U Plenum, Belden 1560A, 9259, 82259, 89259, 88241
F1	RG-59/U Plenum 20 AWG center conductor, Belden 82108
G1	RG-6, 143, 212
G2	8X, LMR240, Belden 7808A, 9258
G3	LMR400, Belden 7810A, 8214, 9913
G4	RG-8, 8A, 9, 87A, 213, 214, 225, 393
G5	RD-6/U
H	RG-11
H1	Belden 1694A, 9248
H2	Belden 1859A, 7731, 8213, 9292
H3	RG-54A/U
I	AT&T 734A, Belden 1505A
I2	AT&T 735A, Belden 735A1
J	Quad 59 headend cable
K	LMR600
K2	Belden 1695A
K3	RG-122, 180, 195, Belden 1855, 1865A, 8218
L	.141 semi-rigid, RG-402/U
L2	.085, .086, .087 semi-rigid, RG-405/U
L3	.250 semi-rigid
L4	.047 semi-rigid, Belden 1674
M	1/2 inch annular corrugated
M1	1 1/4 inch annular corrugated
M2	1 5/8 inch annular corrugated
M3	7/8 inch annular corrugated
N	1/4 Helical
N1	3/8 Helical
N2	1/2 Helical
N3	7/8 inch SFC
P1	.81 mm OD micro-cable
P2	1.13 mm OD micro-cable, TCB-068
P3	1.32 mm OD micro-cable
P4	1.37 mm OD micro-cable