

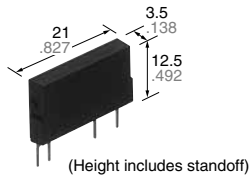

**Slim and high capacity
up to 3.6A
Voltage-driven type**

**PhotoMOS®
Power 1 Form A**
Voltage-sensitive (AQZ100D, 200D)



mm inch

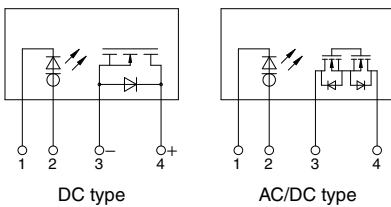

RoHS compliant

FEATURES

1. A voltage-sensitive power PhotoMOS

Conventional power PhotoMOS are connected externally to an input limiting resistor in order to obtain the appropriate LED current. Adding an internal constant-current element renders the input limiting resistor unnecessary, making it possible for the PhotoMOS to be voltage-driven.

2. Wide range of input voltages

Allows a wide range of input voltages from 4 to 30 V DC. The PhotoMOS can be used in 5 V, 12 V or 24 V DC systems.

3. Both AC/DC dual types and DC-only types available

The AC/DC dual type is capable of bi-directional control, and unlike conventional SSRs, does not have to be used differently depending on the load. The DC-only type is well suited for control of DC solenoids and DC motors.

4. High capacity

Supports the various types of load control, from very small loads to a max. 2.7 A for the AC/DC dual type, max. 3.6 A for the DC-only type.

5. High sensitivity and low on-resistance

Max. 3.6 A load can be controlled with the min. input voltage of 4 V DC. The on-resistance is also low at Typ. 0.033 Ω (AQZ102D).

6. Slim SIL4-pin package

(W) 3.5 × (D) 21.0 × (H) 12.5 mm
(W) .138 × (D) .827 × (H) .492 inch

The compact size of the 4-pin SIL package allows high density mounting.

TYPICAL APPLICATIONS

- Industrial machines
- Traffic signals

TYPES

1. DC type

	Output rating*		Package	Part No.	Packing quantity	
	Load voltage	Load current			Inner carton	Outer carton
DC only	60 V	3.6 A	SIL4-pin	AQZ102D	25 pcs.	500 pcs.
	100 V	2.3 A		AQZ105D		
	200 V	1.1 A		AQZ107D		
	400 V	0.6 A		AQZ104D		

* Load voltage and current of DC type: DC

2. AC/DC type

	Output rating*		Package	Part No.	Packing quantity	
	Load voltage	Load current			Inner carton	Outer carton
AC/DC dual use	60 V	2.7 A	SIL4-pin	AQZ202D	25 pcs.	500 pcs.
	100 V	1.8 A		AQZ205D		
	200 V	0.9 A		AQZ207D		
	400 V	0.45 A		AQZ204D		

* Load voltage and current of AC/DC type: Peak AC/DC

Power 1 Form A Voltage-sensitive (AQZ100D, 200D)

RATING

1. DC type

1) Absolute maximum ratings (Ambient temperature: 25°C 77°F)

Item		Symbol	AQZ102D	AQZ105D	AQZ107D	AQZ104D	Remarks
Input	Input voltage	V_{IN}	30 V				
	Input reverse voltage	V_{RIN}	5 V				
	Power dissipation	P_{in}	300 mW				
Output	Load voltage (DC)	V_L	60 V	100 V	200 V	400 V	
	Continuous load current (DC)	I_L	3.6 A	2.3 A	1.1 A	0.6 A	
	Peak load current	I_{peak}	9.0 A	6.0 A	3.0 A	1.5 A	100 ms (1 shot), $V_L = DC$
	Power dissipation	P_{out}	1.35 W				
Total power dissipation		P_T	1.35 W				
I/O isolation voltage		V_{iso}	2,500 Vrms				
Ambient temperature	Operating	T_{opr}	-40 to +85°C -40 to +185°F (4 V $\leq V_{IN} \leq$ 6 V) -40 to +75°C -40 to +167°F (6 V < $V_{IN} \leq$ 15 V) -40 to +60°C -40 to +140°F (15 V < $V_{IN} \leq$ 30 V)				(Non-icing at low temperatures)
	Storage	T_{stg}	-40 to +100°C -40 to +212°F				

2) Electrical characteristics (Ambient temperature: 25°C 77°F)

Item		Symbol	AQZ102D	AQZ105D	AQZ107D	AQZ104D	Condition
Input	Operate voltage	Typical	1.4 V				$I_L = 100$ mA $V_L = 10$ V
		Maximum	4 V				
	Turn off voltage	Minimum	0.8 V				$I_L = 100$ mA $V_L = 10$ V
Typical		1.3 V					
Input current		Typical	6.5 mA				$V_{IN} = 5$ V
Output	On resistance	Typical	0.033 Ω	0.090 Ω	0.33 Ω	1.23 Ω	$V_{IN} = 5$ V $I_L = Max.$ Within 1 s
		Maximum	0.09 Ω	0.17 Ω	0.55 Ω	1.6 Ω	
Off state leakage current		Maximum	10 μ A				$V_{IN} = 0$ V $V_L = Max.$
Transfer characteristics	Turn on time*	Typical	3.3 ms	2.2 ms	1.5 ms	1.2 ms	$V_{IN} = 5$ V $I_L = 100$ mA $V_L = 10$ V
		Maximum	10.0 ms				
	Turn off time*	Typical	0.2 ms		0.1 ms		$V_{IN} = 5$ V $I_L = 100$ mA $V_L = 10$ V
		Maximum	3.0 ms				
	I/O capacitance	Typical	0.8 pF				$f = 1$ MHz $V_B = 0$ V
		Maximum	1.5 pF				
Initial I/O isolation resistance		Minimum	1,000 M Ω				500 V DC
Max. operating frequency		Maximum	0.5 cps				$V_{IN} = 5$ V Duty factor = 50% $I_L = Max., V_L = Max.$

2. AC/DC type

1) Absolute maximum ratings (Ambient temperature: 25°C 77°F)

Item		Symbol	AQZ202D	AQZ205D	AQZ207D	AQZ204D	Remarks
Input	Input voltage	V_{IN}	30 V				
	Input reverse voltage	V_{RIN}	5 V				
	Power dissipation	P_{in}	300 mW				
Output	Load voltage (peak AC)	V_L	60 V	100 V	200 V	400 V	
	Continuous load current	I_L	2.7 A	1.8 A	0.9 A	0.45 A	Peak AC, DC
	Peak load current	I_{peak}	9.0 A	6.0 A	3.0 A	1.5 A	100 ms (1 shot), $V_L = DC$
	Power dissipation	P_{out}	1.6 W				
Total power dissipation		P_T	1.6 W				
I/O isolation voltage		V_{iso}	2,500 Vrms				
Ambient temperature	Operating	T_{opr}	-40 to +85°C -40 to +185°F (4 V $\leq V_{IN} \leq$ 6 V) -40 to +75°C -40 to +167°F (6 V < $V_{IN} \leq$ 15 V) -40 to +60°C -40 to +140°F (15 V < $V_{IN} \leq$ 30 V)				(Non-icing at low temperatures)
	Storage	T_{stg}	-40 to +100°C -40 to +212°F				

Power 1 Form A Voltage-sensitive (AQZ100D, 200D)

2) Electrical characteristics (Ambient temperature: 25°C 77°F)

Item		Symbol	AQZ202D	AQZ205D	AQZ207D	AQZ204D	Condition	
Input	Operate voltage	Typical	1.4 V				$I_L = 100 \text{ mA}$ $V_L = 10 \text{ V}$	
		Maximum	4 V					
	Turn off voltage	Minimum	0.8 V				$I_L = 100 \text{ mA}$ $V_L = 10 \text{ V}$	
		Typical	1.3 V					
Input current	Typical	I_{IN}	6.5 mA				$V_{IN} = 5 \text{ V}$	
Output	On resistance	Typical	0.066 Ω	0.180 Ω	0.64 Ω	2.4 Ω	$V_{IN} = 5 \text{ V}$ $I_L = \text{Max.}$ Within 1 s	
		Maximum	0.18 Ω	0.34 Ω	1.1 Ω	3.2 Ω		
	Off state leakage current	Maximum	I_{Leak}	10 μA				$V_{IN} = 0 \text{ V}$ $V_L = \text{Max.}$
Transfer characteristics	Turn on time*	Typical	5.8 ms	4.2 ms	2.7 ms	2.3 ms	$V_{IN} = 5 \text{ V}$ $I_L = 100 \text{ mA}$ $V_L = 10 \text{ V}$	
		Maximum	10.0 ms					
	Turn off time*	Typical	0.2 ms		0.1 ms		$V_{IN} = 5 \text{ V}$ $I_L = 100 \text{ mA}$ $V_L = 10 \text{ V}$	
		Maximum	3.0 ms					
	I/O capacitance	Typical	C_{iso}	0.8 pF				$f = 1 \text{ MHz}$ $V_B = 0 \text{ V}$
		Maximum		1.5 pF				
	Initial I/O isolation resistance	Minimum	R_{iso}	1,000 M Ω				500 V DC
Max. operating frequency	Maximum	—	0.5 cps				$V_{IN} = 5 \text{ V}$ Duty factor = 50% $I_L = \text{Max.}, V_L = \text{Max.}$	

*Turn on/off time

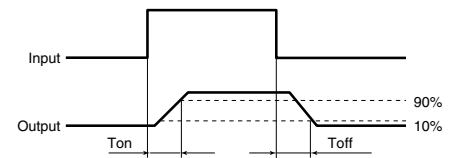

3. Recommended operating conditions (Ambient temperature: 25°C 77°F)

Please use under recommended operating conditions to obtain expected characteristics.

Item	Symbol	Min.	Max.	Unit	
Input voltage	V_{IN}	5	24	V	
AQZ102D	Load voltage (DC)	V_L	—	48	V
	Continuous load current (DC)	I_L	—	3.6	A
AQZ105D	Load voltage (DC)	V_L	—	80	V
	Continuous load current (DC)	I_L	—	2.3	A
AQZ107D	Load voltage (DC)	V_L	—	160	V
	Continuous load current (DC)	I_L	—	1.1	A
AQZ104D	Load voltage (DC)	V_L	—	320	V
	Continuous load current (DC)	I_L	—	0.6	A
AQZ202D	Load voltage (Peak AC)	V_L	—	48	V
	Continuous load current	I_L	—	2.7	A
AQZ205D	Load voltage (Peak AC)	V_L	—	80	V
	Continuous load current	I_L	—	1.8	A
AQZ207D	Load voltage (Peak AC)	V_L	—	160	V
	Continuous load current	I_L	—	0.9	A
AQZ204D	Load voltage (Peak AC)	V_L	—	320	V
	Continuous load current	I_L	—	0.45	A

■ These products are not designed for automotive use.

If you are considering to use these products for automotive applications, please contact your local Panasonic Corporation technical representative.

REFERENCE DATA

1. Load current vs. ambient temperature characteristics

Allowable ambient temperature: -40 to $+85^{\circ}\text{C}$
 -40 to $+185^{\circ}\text{F}$;

V_{IN} : Input voltage; I_L (derate): Load current (derate); I_L : Absolute maximum ratings of continuous load current

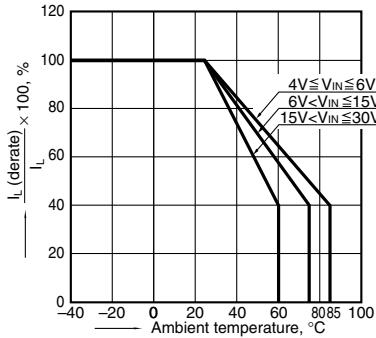

2.-(1) Load current vs. ambient temperature characteristics in adjacent mounting

Input voltage: $4\text{V} \leq V_{IN} \leq 6\text{V}$;
 I_L (derate): Load current (derate); I_L : Absolute maximum ratings of continuous load current; ℓ : Adjacent mounting pitch

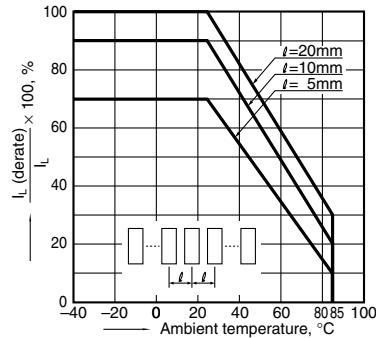

2.-(2) Load current vs. ambient temperature characteristics in adjacent mounting

Input voltage: $6\text{V} < V_{IN} \leq 15\text{V}$;
 I_L (derate): Load current (derate); I_L : Absolute maximum ratings of continuous load current; ℓ : Adjacent mounting pitch

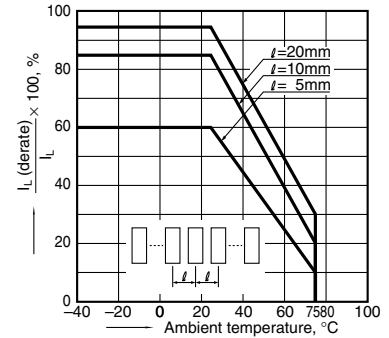

2.-(3) Load current vs. ambient temperature characteristics in adjacent mounting

Input voltage: $15\text{V} < V_{IN} \leq 30\text{V}$;
 I_L (derate): Load current (derate); I_L : Absolute maximum ratings of continuous load current; ℓ : Adjacent mounting pitch

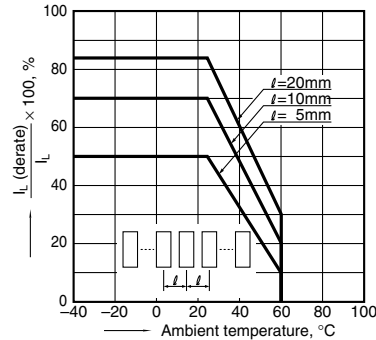

3.-(1) On resistance vs. ambient temperature characteristics (DC type)

Input voltage: 5 V;
 Continuous load current: 3.6 A (DC) (AQZ102D)
 2.3 A (DC) (AQZ105D)

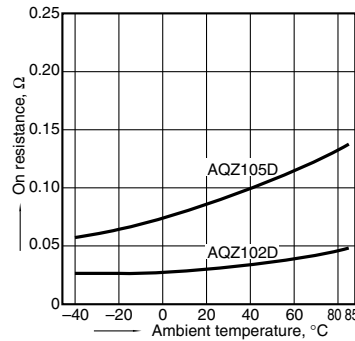

3.-(2) On resistance vs. ambient temperature characteristics (DC type)

Input voltage: 5 V;
 Continuous load current: 1.1 A (DC) (AQZ107D)
 0.6 A (DC) (AQZ104D)

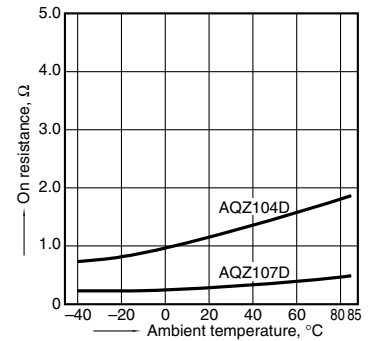

3.-(3) On resistance vs. ambient temperature characteristics (AC/DC type)

Input voltage: 5 V;
 Continuous load current: 2.7 A (DC) (AQZ202D)
 1.8 A (DC) (AQZ205D)

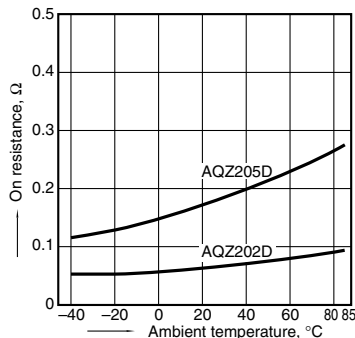

3.-(4) On resistance vs. ambient temperature characteristics (AC/DC type)

Input voltage: 5 V;
 Continuous load current: 0.9 A (DC) (AQZ207D)
 0.45 A (DC) (AQZ204D)

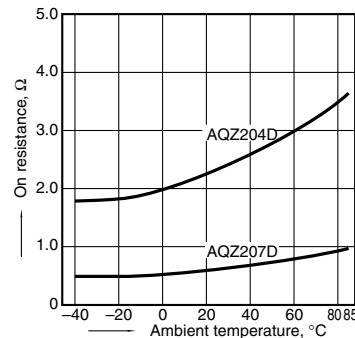

4.-(1) Turn on time vs. ambient temperature characteristics (DC type)

Input voltage: 5 V; Load voltage: 10 V (DC);
 Continuous load current: 100 mA (DC)

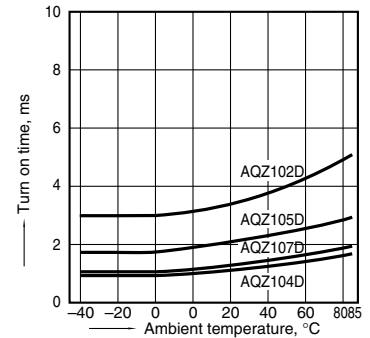

4.-(2) Turn on time vs. ambient temperature characteristics (AC/DC type)

Input voltage: 5 V;
Load voltage: 10 V (DC);
Continuous load current: 100 mA (DC)

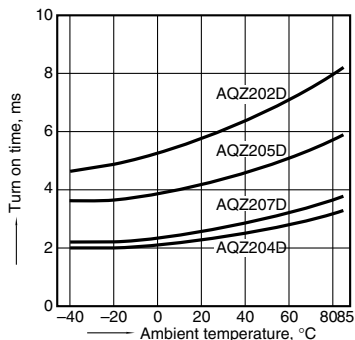

5.-(1) Turn off time vs. ambient temperature characteristics (DC type)

Input voltage: 5 V; Load voltage: 10 V (DC);
Continuous load current: 100 mA (DC)

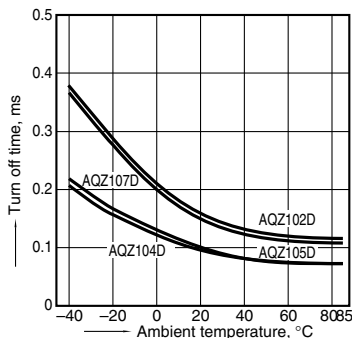

5.-(2) Turn off time vs. ambient temperature characteristics (AC/DC type)

Input voltage: 5 V; Load voltage: 10 V (DC);
Continuous load current: 100 mA (DC)

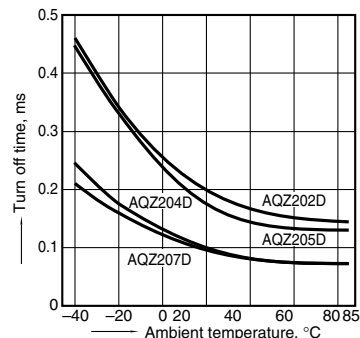

6. Operate voltage vs. ambient temperature characteristics

Load voltage: 10 V (DC);
Continuous load current: 100 mA (DC)

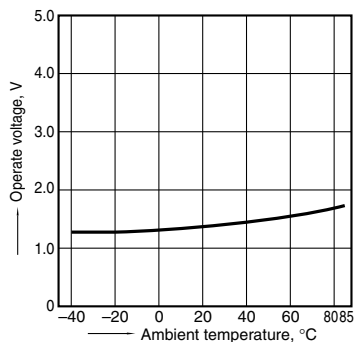

7. Turn off voltage vs. ambient temperature characteristics

Load voltage: 10 V (DC);
Continuous load current: 100 mA (DC)

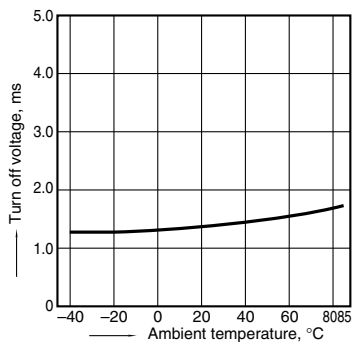

8. Input current vs. ambient temperature characteristics

Input voltage: 5 V

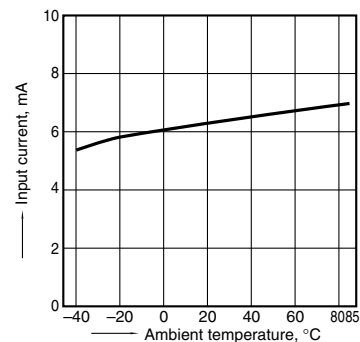

9.-(1) Current vs. voltage characteristics of output at MOS portion (DC type)

Ambient temperature: 25°C 77°F

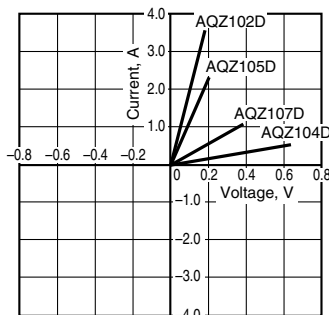

9.-(2) Current vs. voltage characteristics of output at MOS portion (AC/DC type)

Ambient temperature: 25°C 77°F

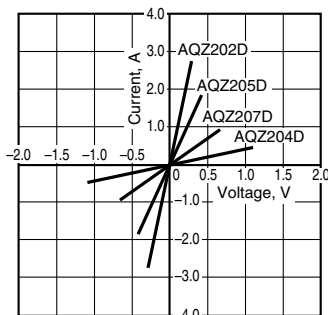

10. Input current vs. input voltage characteristics

Ambient temperature: 25°C 77°F

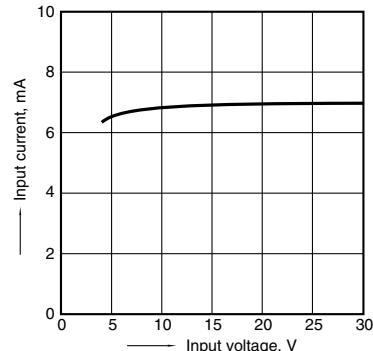

Power 1 Form A Voltage-sensitive (AQZ100D, 200D)

11.-(1) Off state leakage current vs. load voltage characteristics
Ambient temperature: 25°C 77°F

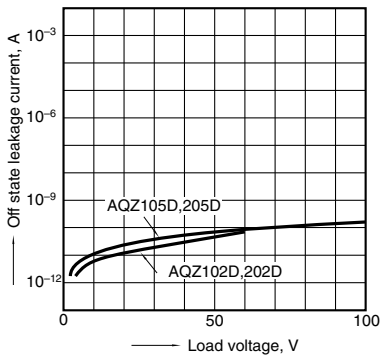

11.-(2) Off state leakage current vs. load voltage characteristics
Ambient temperature: 25°C 77°F

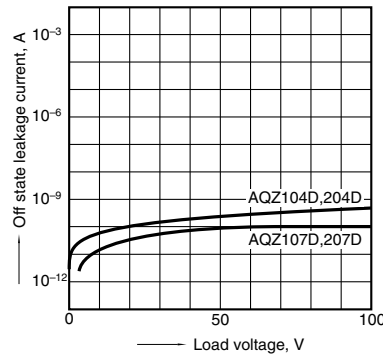

12. Max. operating frequency vs. load voltage/current characteristics
Sample: All types; LED current: 10 mA;
Ambient temperature: 25°C 77°F
V_L: Load voltage, V_L (Max.): Max. rated load voltage
I_L: Load current, I_L (Max.): Max. rated continuous load current

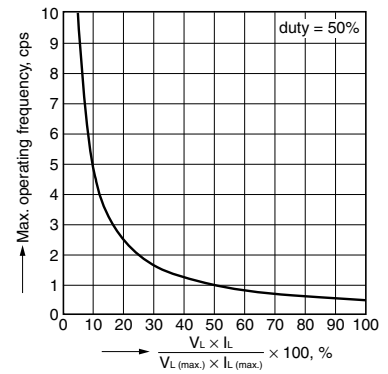

13.-(1) Output capacitance vs. applied voltage characteristics (DC type)
Frequency: 1 MHz; Ambient temperature: 25°C 77°F

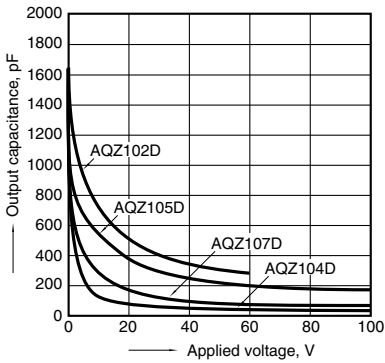

13.-(2) Output capacitance vs. applied voltage characteristics (AC/DC type)
Frequency: 1 MHz; Ambient temperature: 25°C 77°F

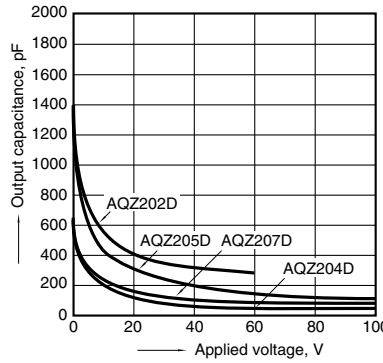

ACCESSORY (mm inch)

Socket

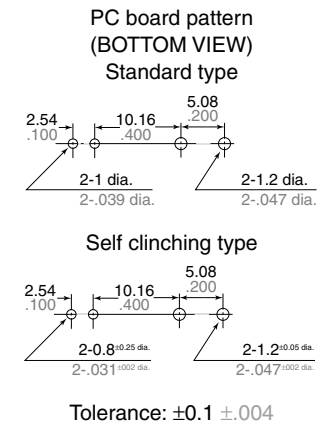
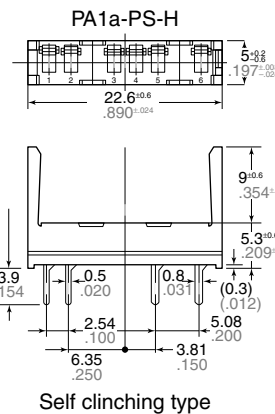
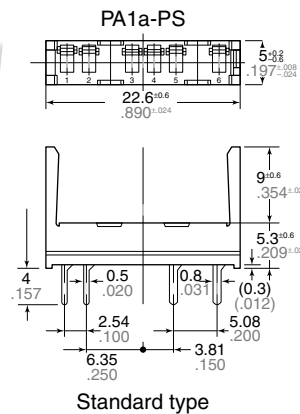

"PhotoMOS®", "PhotoMOS" and "PHOTOMOS" are registered trademarks of Panasonic Corporation.

*Recognized in Japan, the United States, all member states of European Union and other countries.

Please contact

Panasonic Corporation

Electromechanical Control Business Division

■ 1006, Oaza Kadoma, Kadoma-shi, Osaka 571-8506, Japan
industrial.panasonic.com/ac/e/

Panasonic®

©Panasonic Corporation 2017