

General Purpose Transistors

PNP Silicon

These transistors are designed for general purpose amplifier applications. They are housed in the SOT-323/SC-70 which is designed for low power surface mount applications.

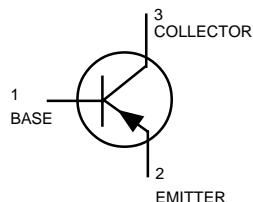

BC856AWT1, BWT1
BC857AWT1, BWT1
BC858AWT1, BWT1
CWT1

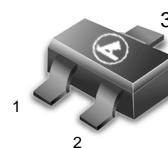

CASE 419-02, STYLE 3
SOT- 323 / SC-70

MAXIMUM RATINGS

Rating	Symbol	BC856	BC857	BC858	Unit
Collector-Emitter Voltage	V_{CEO}	-65	-45	-30	V
Collector-Base Voltage	V_{CBO}	-80	-50	-30	V
Emitter-Base Voltage	V_{EBO}	-5.0	-5.0	-5.0	V
Collector Current — Continuous	I_C	-100	-100	-100	mAdc

THERMAL CHARACTERISTICS

Characteristic	Symbol	Max	Unit
Total Device Dissipation FR-5 Board, (1) $T_A = 25^\circ\text{C}$	P_D	150	mW
Thermal Resistance, Junction to Ambient	$R_{\theta JA}$	833	$^\circ\text{C/W}$
Junction and Storage Temperature	T_J, T_{stg}	-55 to +150	$^\circ\text{C}$

DEVICE MARKING

BC856AWT1 = 3A; BC856BWT1 = 3B; BC857AWT1 = 3E; BC857BWT1 = 3F;
 BC858AWT1 = 3J; BC858BWT1 = 3K; BC858CWT1 = 3L

ELECTRICAL CHARACTERISTICS ($T_A = 25^\circ\text{C}$ unless otherwise noted.)

Characteristic	Symbol	Min	Typ	Max	Unit
----------------	--------	-----	-----	-----	------

OFF CHARACTERISTICS

Collector-Emitter Breakdown Voltage ($I_C = -10\text{ mA}$)	BC856 Series	$V_{(BR)CEO}$	-65	—	—	v
	BC857 Series		-45	—	—	
	BC858 Series		-30	—	—	
Collector-Emitter Breakdown Voltage ($I_C = -10\ \mu\text{A}, V_{EB} = 0$)	BC856 Series	$V_{(BR)CES}$	-80	—	—	v
	BC857 Series		-50	—	—	
	BC858 Series		-30	—	—	
Collector-Base Breakdown Voltage ($I_C = -10\ \mu\text{A}$)	BC856 Series	$V_{(BR)CBO}$	-80	—	—	v
	BC857 Series		-50	—	—	
	BC858 Series		-30	—	—	
Emitter-Base Breakdown Voltage ($I_E = -1.0\ \mu\text{A}$)	BC856 Series	$V_{(BR)EBO}$	-5.0	—	—	v
	BC857 Series,		-5.0	—	—	
	BC858 Series		-5.0	—	—	
Collector Cutoff Current ($V_{CB} = -30\text{ V}$) ($V_{CB} = -30\text{ V}, T_A = 150^\circ\text{C}$)		I_{CBO}	—	—	-15	nA
			—	—	-4.0	μA

1.FR-5=1.0 x 0.75 x 0.062in

BC856AWT1, BWT1 BC857AWT1, BWT1 BC858AWT1, BWT1, CWT1

ELECTRICAL CHARACTERISTICS ($T_A = 25^\circ\text{C}$ unless otherwise noted) (Continued)

Characteristic	Symbol	Min	Typ	Max	Unit
----------------	--------	-----	-----	-----	------

ON CHARACTERISTICS

DC Current Gain ($I_C = -10\ \mu\text{A}$, $V_{CE} = -5.0\ \text{V}$)	BC856A, BC857A, BC858A	h_{FE}	—	90	—	—
	BC856B, BC857B, BC858B		—	150	—	
	BC858C,		—	270	—	
($I_C = -2.0\ \text{mA}$, $V_{CE} = -5.0\ \text{V}$)	BC856A, BC857A, BC858A		125	180	250	
	BC856B, BC857B, BC858B		220	290	475	
	BC858C		420	520	800	
Collector–Emitter Saturation Voltage ($I_C = -10\ \text{mA}$, $I_B = -0.5\ \text{mA}$) ($I_C = -100\ \text{mA}$, $I_B = -5.0\ \text{mA}$)		$V_{CE(sat)}$	—	—	-0.3	V
			—	—	-0.65	
Base–Emitter Saturation Voltage ($I_C = -10\ \text{mA}$, $I_B = -0.5\ \text{mA}$) ($I_C = -100\ \text{mA}$, $I_B = -5.0\ \text{mA}$)		$V_{BE(sat)}$	—	-0.7	—	V
			—	-0.9	—	
Base–Emitter Voltage ($I_C = -2.0\ \text{mA}$, $V_{CE} = -5.0\ \text{V}$) ($I_C = -10\ \text{mA}$, $V_{CE} = -5.0\ \text{V}$)		$V_{BE(on)}$	-0.6	—	-0.75	V
			—	—	-0.82	

SMALL–SIGNAL CHARACTERISTICS

Current–Gain — Bandwidth Product ($I_C = -10\ \text{mA}$, $V_{CE} = -5.0\ \text{Vdc}$, $f = 100\ \text{MHz}$)	f_T	100	—	—	MHz
Output Capacitance ($V_{CB} = -10\ \text{V}$, $f = 1.0\ \text{MHz}$)	C_{ob}	—	—	4.5	pF
Noise Figure ($I_C = -0.2\ \text{mA}$, $V_{CE} = -5.0\ \text{Vdc}$, $R_S = 2.0\ \text{k}\Omega$, $f = 1.0\ \text{kHz}$, $BW = 200\ \text{Hz}$)	NF	—	—	10	dB

BC856AWT1, BWT1 BC857AWT1, BWT1, BC858AWT1, BWT1, CWT1

BC857/BC858

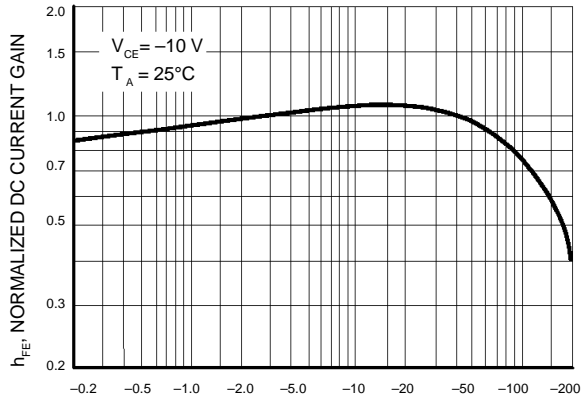

I_C , COLLECTOR CURRENT (mAdc)
Figure 1. Normalized DC Current Gain

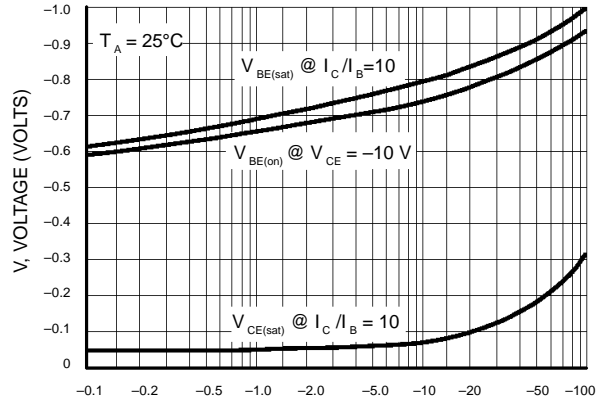

I_C , COLLECTOR CURRENT (mAdc)
Figure 2. "Saturation" and "On" Voltages

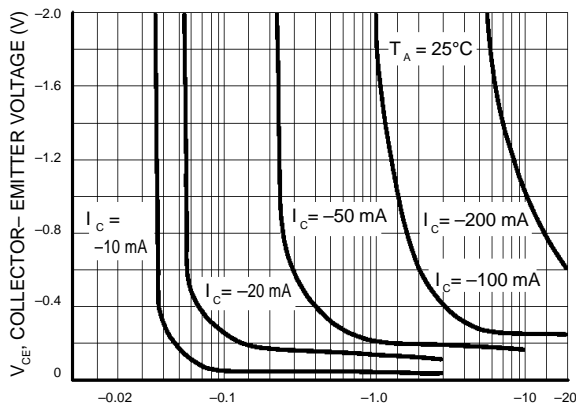

I_B , BASE CURRENT (mA)
Figure 3. Collector Saturation Region

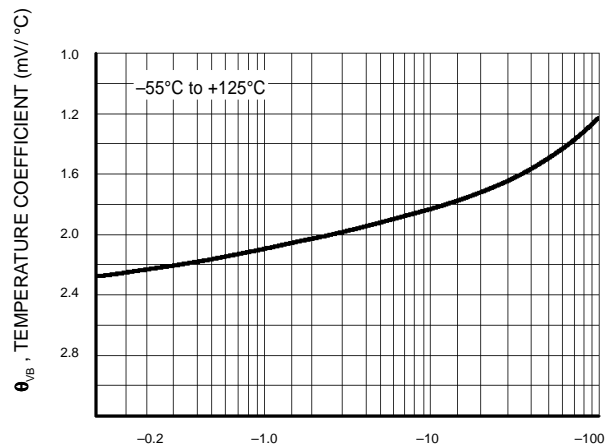

I_C , COLLECTOR CURRENT (mA)
Figure 4. Base-Emitter Temperature Coefficient

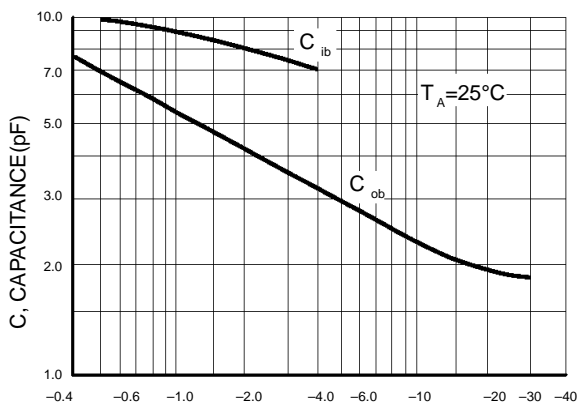

V_R , REVERSE VOLTAGE (VOLTS)
Figure 5. Capacitances

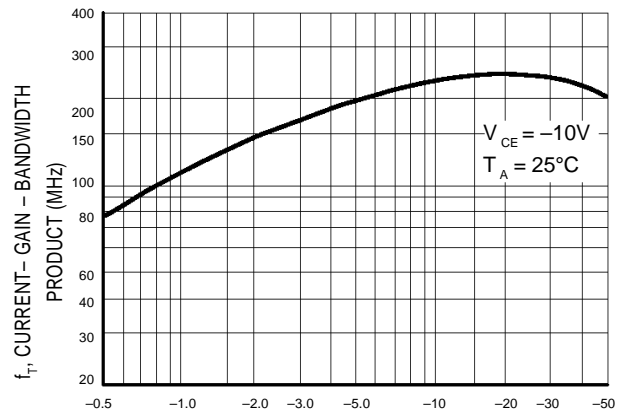

I_C , COLLECTOR CURRENT (mAdc)
Figure 6. Current-Gain - Bandwidth Product

BC856AWT1, BWT1 BC857AWT1, BWT1, BC858AWT1, BWT1, CWT1

BC856

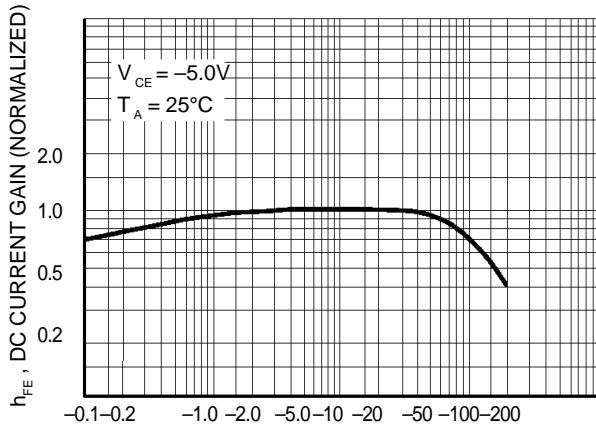

Figure 7. DC Current Gain

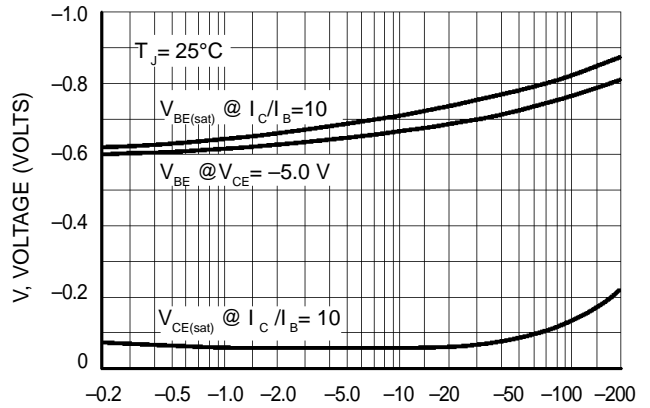

Figure 8. "On" Voltage

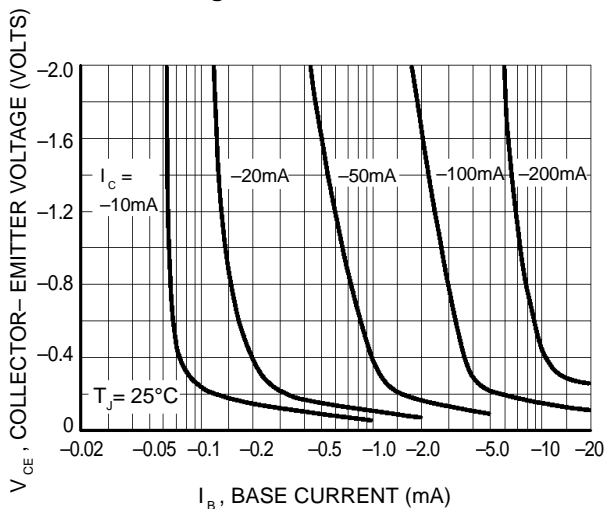

Figure 9. Collector Saturation Region

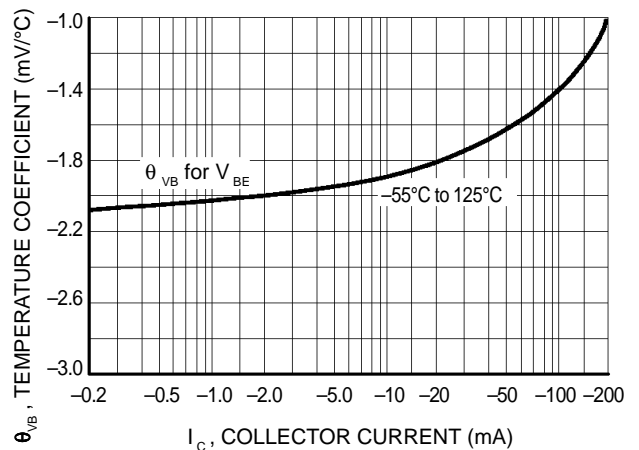

Figure 10. Base-Emitter Temperature Coefficient

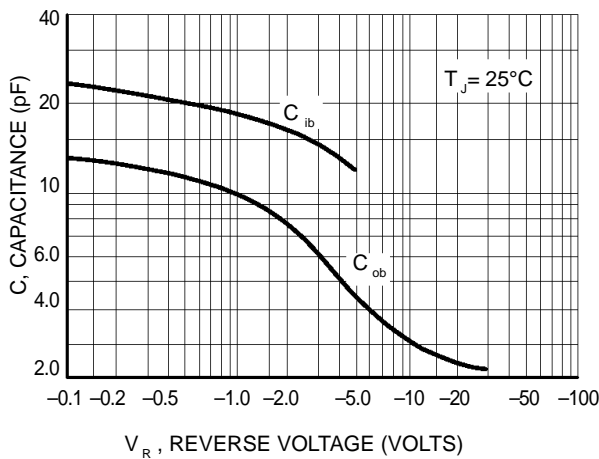

Figure 11. Capacitance

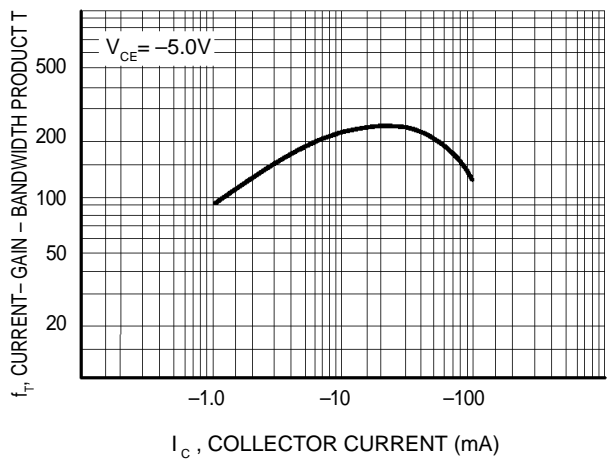

Figure 12. Current-Gain - Bandwidth Product

BC856AWT1, BWT1 BC857AWT1, BWT1, BC858AWT1, BWT1, CWT1

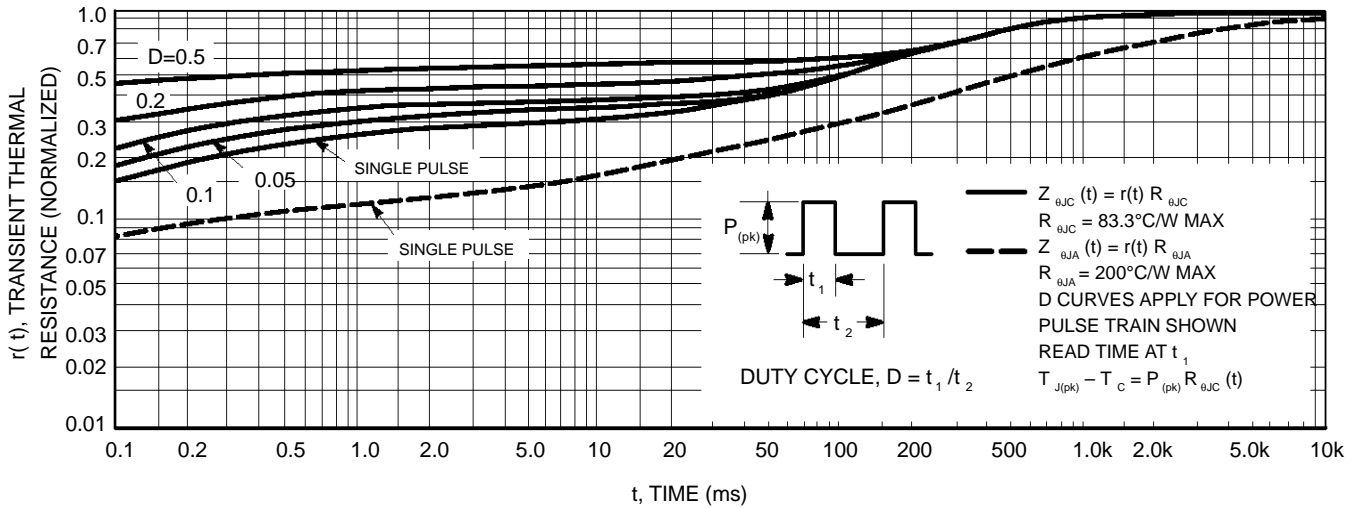

Figure 13. Thermal Response

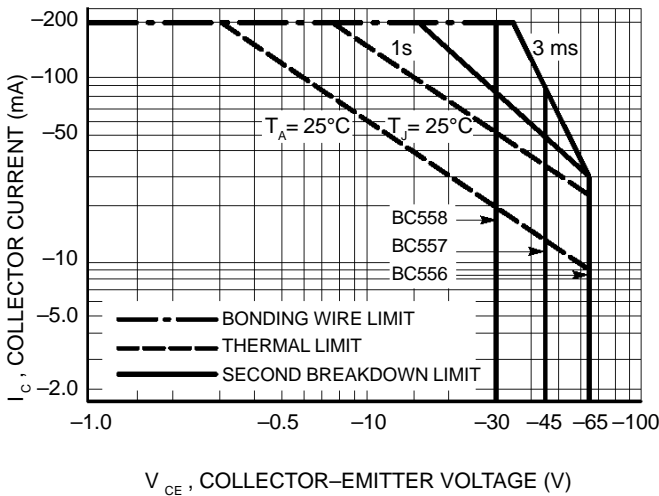

Figure 14. Active Region Safe Operating Area

The safe operating area curves indicate $I_C - V_{CE}$ limits of the transistor that must be observed for reliable operation. Collector load lines for specific circuits must fall below the limits indicated by the applicable curve.

The data of Figure 14 is based upon $T_{J(pk)} = 150^\circ\text{C}$; T_C or T_A is variable depending upon conditions. Pulse curves are valid for duty cycles to 10% provided $T_{J(pk)} \leq 150^\circ\text{C}$. $T_{J(pk)}$ may be calculated from the data in Figure 13. At high case or ambient temperatures, thermal limitations will reduce the power that can be handled to values less than the limitations imposed by the secondary breakdown.