

T-1³/₄ (5 mm), T-1 (3 mm), Low Current LED Lamps

Technical Data

HLMP-4700, -4719, -4740
HLMP-1700, -1719, -1790

Features

- Low Power
- High Efficiency
- CMOS-MOS Compatible
- TTL Compatible
- Wide Viewing Angle
- Choice of Package Styles
- Choice of Colors

- Portable Equipment
- Keyboard Indicators

Applications

- Low Power DC Circuits
- Telecommunications Indicators

Description

These tinted diffused LED lamps are designed and optimized specifically for low DC current operation. Luminous intensity and forward voltage are tested at 2 mA to assure consistent brightness at TTL output current levels.

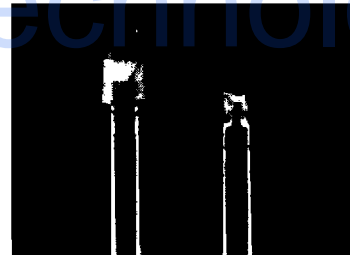

Package Dimensions

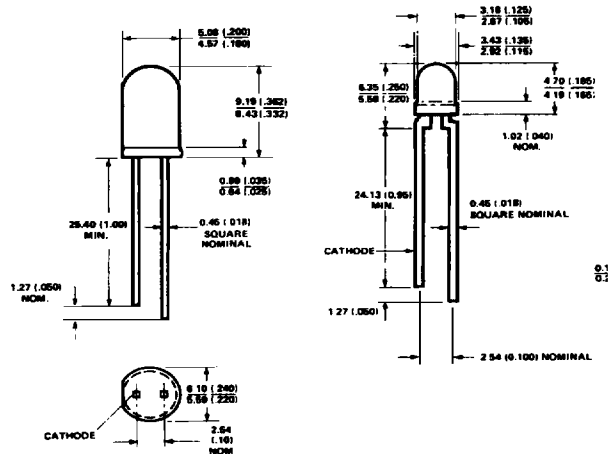

NOTES:
1. ALL DIMENSIONS ARE IN MILLIMETRES (INCHES).
2. AN EPOXY MINISCUS MAY EXTEND ABOUT 1 mm (0.040") DOWN THE LEADS.

HLMP-4700, -4719, -4740

HLMP-1700, -1719, -1790

A

B



Low Current Lamp Selection Guide

Size	Color		
	HER HLMP-	Yellow HLMP-	Green HLMP-
T-1 ^{3/4}	4700	4719	4740
T-1	1700	1719	1790

Axial Luminous Intensity and Viewing Angle @ 25°C

Part Number HLMP-	Package Description	Color	I _v (mcd) @ 2 mA DC		2θ ^{1/2} [1]	Package Outline
			Min.	Typ.		
4700 4719 4740	T-1 ^{3/4} Tinted Diffused	Red Yellow Green	1.3 0.9 1.0	2.3 2.1 2.3	50°	A
1700 1719 1790	T-1 Tinted Diffused	Red Yellow Green	0.8 0.9 1.0	2.1 1.6 2.1	50°	B

Note:

1. θ^{1/2} is the typical off-axis angle at which the luminous intensity is half the axial luminous intensity.

Electrical/Optical Characteristics at $T_A = 25^\circ\text{C}$

Symbol	Description	T-1 ^{3/4}	T-1	Min.	Typ.	Max.	Units	Test Conditions
V_F	Forward Voltage	4700 4719 4740	1700 1719 1790		1.8 1.9 1.8	2.0 2.5 2.2	V	2 mA
V_R	Reverse Breakdown Voltage	4700 4719 4740	1700 1719 1790	5.0 5.0 5.0			V	$I_R = 50 \mu\text{A}$
λ_d	Dominant Wavelength	4700 4719 4740	1700 1719 1790		626 585 569		nm	Note 1
$\Delta\lambda_{1/2}$	Spectral Line Halfwidth	4700 4719 4740	1700 1719 1790		40 36 28		nm	
τ_S	Speed of Response	4700 4719 4740	1700 1719 1790		90 90 500		ns	
C	Capacitance	4700 4719 4740	1700 1719 1790		11 15 18		pF	$V_F = 0$, $f = 1 \text{ MHz}$
$R\theta_{J-PIN}$	Thermal Resistance	4700 4719 4740	1700 1719 1790		260 ^[3] 290 ^[4]		$^\circ\text{C/W}$	Junction to Cathode Lead
λ_{PEAK}	Peak Wavelength	4700 4719 4740	1700 1719 1790		635 583 565		nm	Measurement at peak
η_V	Luminous Efficacy	4700 4719 4740	1700 1719 1790		145 500 595		<u>lumens</u> watt	Note 2

Notes:

1. The dominant wavelength, λ_d , is derived from the CIE chromaticity diagram and represents the single wavelength which defines the color of the device.
2. The radiant intensity, I_e , in watts per steradian, may be found from the equation $I_e = I_v/\eta_V$, where I_v is the luminous intensity in candelas and η_V is luminous efficacy in lumens/watt.
3. T-1^{3/4}.
4. T-1.

Absolute Maximum Ratings

Parameter	Maximum Rating		Units
	Power Dissipation (Derate linearly from 92°C at 1.0 mA/°C)	Red Yellow Green	
DC and Peak Forward Current	7		mA
Transient Forward Current (10 μs Pulse) ^[1]	500		mA
Reverse Voltage (I _R = 50 μA)	5.0		V
Operating Temperature Range	Red/Yellow Green	-55°C to 100°C -20°C to 100°C	
Storage Temperature Range	-55°C to +100°C		
Lead Soldering Temperature [1.6 mm (0.063 in.) from body]	260°C for 5 seconds		

Note:

1. The transient peak current is the maximum non-recurring peak current the devices can withstand without damaging the LED die and wire bonds. It is not recommended that the device be operated at peak currents beyond the Absolute Maximum Peak Forward Current.

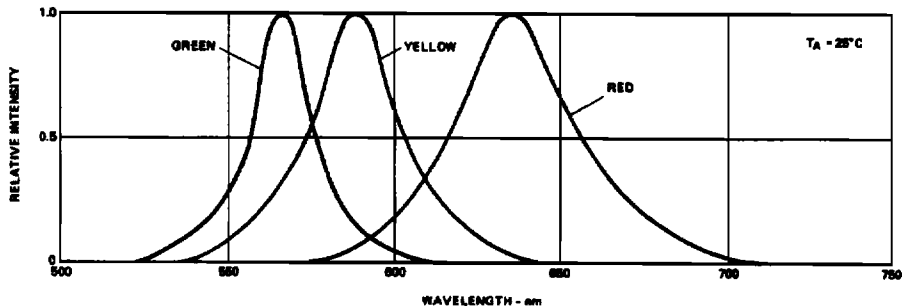

Figure 1. Relative Intensity vs. Wavelength.

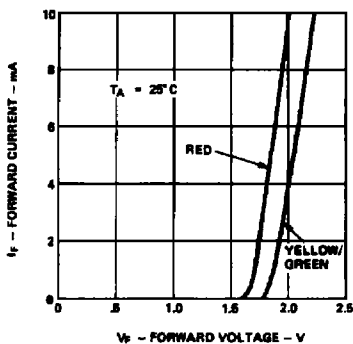

Figure 2. Forward Current vs. Forward Voltage.

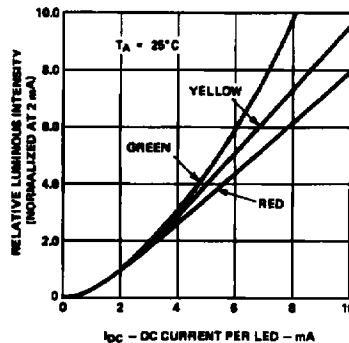

Figure 3. Relative Luminous Intensity vs. Forward Current.

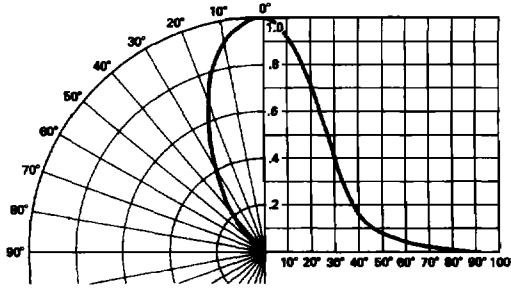

Figure 4. Relative Luminous Intensity vs. Angular Displacement for T-1^{3/4} Lamp.

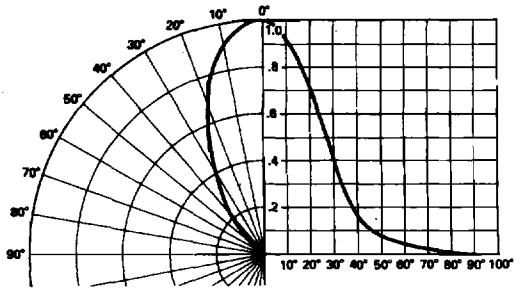

Figure 5. Relative Luminous Intensity vs. Angular Displacement for T-1 Lamp.